

PO-290-BRIXIA (OPTIONAL SOFT-CLOSE)

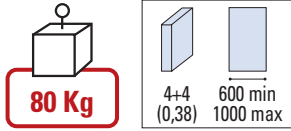

SIMPLE

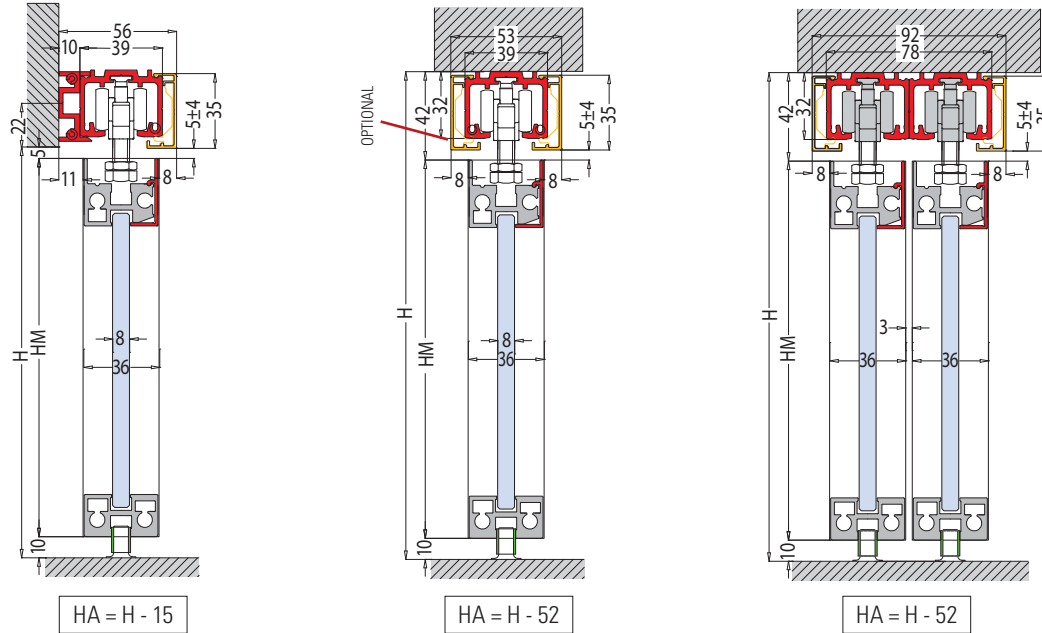

COMPONENTI / COMPONENTS / EINZELTEILE ▶ 56

SIMPLE

PO-290-BRIXIA SET 1-P

€▶A.119

• Parete • Wall • Wand

PO-290-BRIXIA SET 2-P

€▶A.120

• Parete • Wall • Wand

PO-290-BRIXIA SET 5

€▶A.123

PO-290-BRIXIA SET 1-S

€▶A.121

• Soffitto • Ceiling • Decke

PO-290-BRIXIA SET 2-S

€▶A.122

• Soffitto • Ceiling • Decke

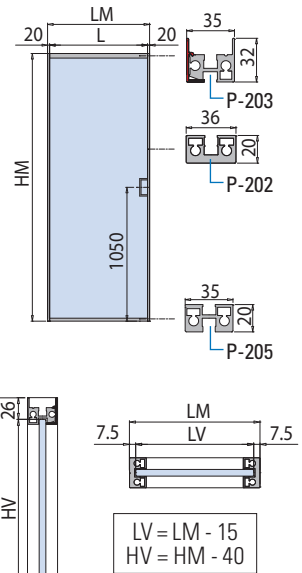
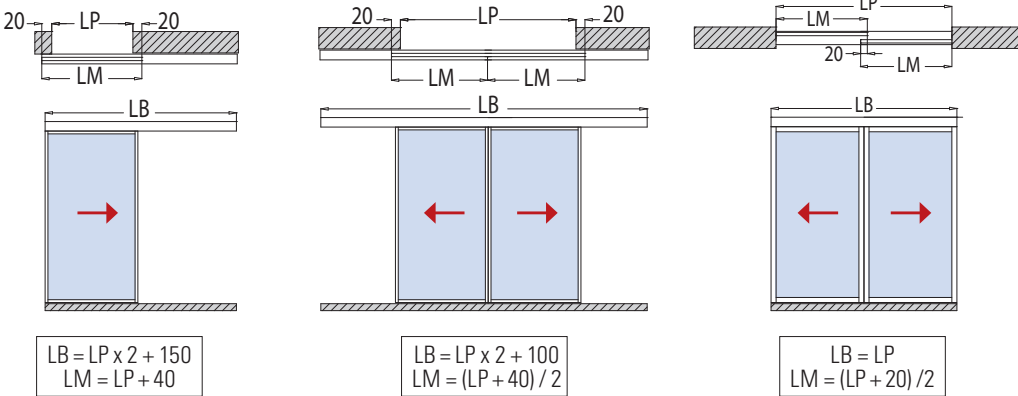

xme425h-g

Cod.	Fin. / Fin. Oberf.	PO-290-BRIXIA SET 1 FIX	PO-290-BRIXIA SET 1 MIS	PO-290-BRIXIA SET 2 FIX	PO-290-BRIXIA SET 2 MIS	PO-290-BRIXIA SET 5 FIX	PO-290-BRIXIA SET 5 MIS
V-1860 LB=2000 LB=3000 LB=4000 LB=6000	AN	1	-	1	-	2	-
V-1860-MIS LB= 1500→6000	AN	-	1	-	1	-	2
V-1829 LB=2000 LB=3000 LB=4000 LB=6000	AN	1	-	1	-	2	-
V-1829-MIS LB= 1500→6000	AN	-	1	-	1	-	2
V-1827 LB=2000 LB=3000 LB=4000 LB=6000	AN	1	-	1	-	-	-
V-1827-MIS LB= 1500→6000	AN	-	1	-	1	-	2
PO-290 - BRIXIA	AN	1	1	2	2	2	2
V-1824-70 Soft-close (OPTIONAL)	-	(1) (2)	(1) (2)	(2) (4)	(2) (4)	(2) (4)	(2) (4)
V-1824-50 Soft-close (OPTIONAL)	-	(1) (2)	(1) (2)	(2) (4)	(2) (4)	(2) (4)	(2) (4)
V-1818 Tappi / Endcaps / Endkappe	AN	1	1	-	-	-	-

V-1860 / V-1863 PO-290-BRIXIA HEAVY (OPTIONAL SOFT-CLOSE)

COMPONENTI / COMPONENTS / EINZELTEILE

SIMPLE

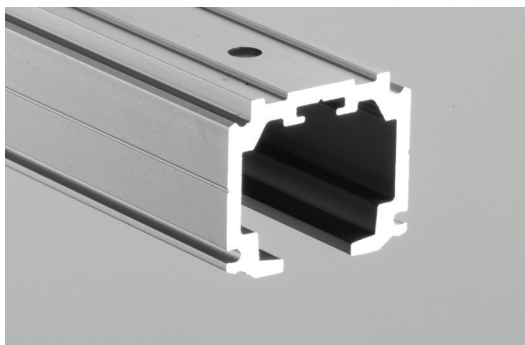

V-1860

- Binario Scorrevole BRIXIA HEAVY
 - Track profile BRIXIA HEAVY
 - Laufschienenprofil BRIXIA HEAVY
- AN

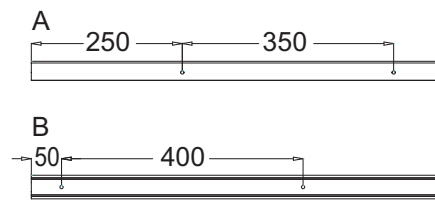
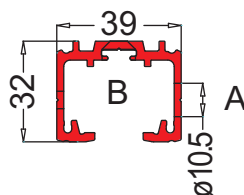

€▶A.124

xme425i



V-1821

- Veletta per binari BRIXIA HEAVY
 - Cover profile for track profiles BRIXIA HEAVY
 - Profilabdeckung für Laufschienenprofile BRIXIA HEAVY
- AN



€▶A.126

xme425i



V-1834

- Profilo per vetro fisso BRIXIA HEAVY
 - Side panel profile BRIXIA HEAVY
 - Seitenteilprofil BRIXIA HEAVY
- AN-IXE

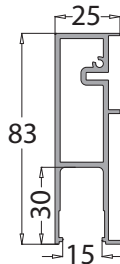

€▶A.125

xme425no

OPTIONAL	
VP-019-MT	VP-018-MT
1000 mm - 2000 mm - 3000 mm	
<ul style="list-style-type: none"> • Guarnizioni per sede vetro fisso • Gaskets for fixed glass • Dichtungen für Seitenteil 	

€▶A.138

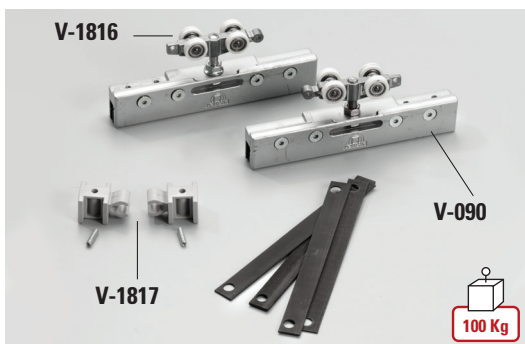

V-1816

V-1817

V-090

100 Kg

V-1862

- Set accessori per 1 anta scorrevole composto da 2 carrelli, morsetti per vetro 8-10 mm. 2 stoppers
- Accessories set for 1 sliding panel consisting of N°2 trolley hangers with clamp carriage for 8/10 mm glass, N°2 endstops
- Zubehör für 1 Schiebetür bestehend aus: N°2 Klemm - Laufwagen für 8/10 mm Glas. N°2 Stopper

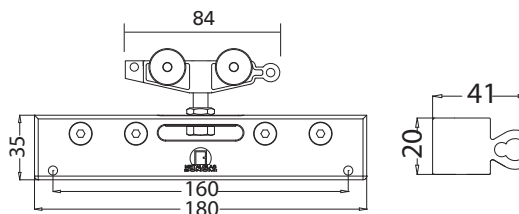

€▶A.127

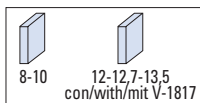

xme425i

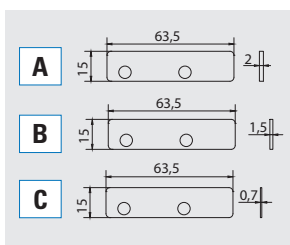

V-1817-A V-1817-B V-1817-C

- Kit spessori per vetro 12 - 12,7 - 13,5 per 2 pinze V-090 e V-090-T
- Kit spacers for glass thickness 12 - 12,7 - 13,5 for 2 clamps V-090 and V-090-T
- Kit Distanzscheiben für Glasdicke 12 - 12,7 - 13,5 für 2 Klemm-Laufwagen V-090 und V-090-T

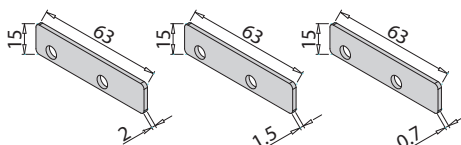

€▶A.133

xme425t

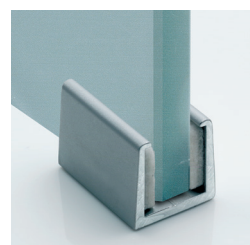

V-012

- Guida a pavimento per scorrevole con feltrini per vetro 8 e 10 mm
 - Floor guide with felt strips for glass sliding door a 8 and 10mm
 - Bodenführung mit Filzgleiter für Glas 8 und 10 mm
- AN - NS

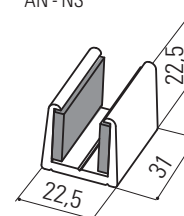

- Altri modelli disponibili a pag. 174
- Other models available on page.174
- Weitere Modelle auf Seite 174

€▶A.130

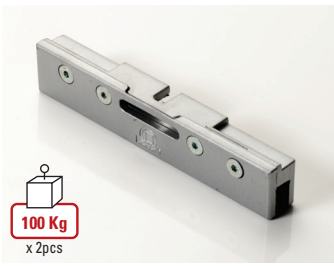

V-090

- Pinza
- Clamp
- Klemmschuh

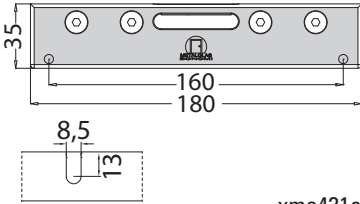
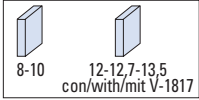

xme431c / xme425a

€▶A.132

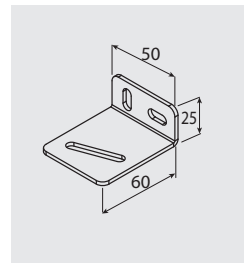

V-1867

- Staffa per fissaggio a parete per sistema V-1863 (circa 1 pezzo ogni 400 mm)
- Angled profile for wall installation for system V-1863 (about 1 piece every 400 mm)
- Winkelverbinder für Wandmontage System V-1863 (1 Stück je ca 400 mm)

SIMPLE

€▶A.135



V-1824-70

soft-close	soft-close
70 Kg	50 Kg
550 min 1 pcs	820 min 2 pcs

V-1824-50

PO-290 BRIXIA	PO-290 BRIXIA
550 min 1 pcs	820 min 2 pcs
600 min 1 pcs	850 min 2 pcs

V-1824-70 - 70 Kg

V-1824-50 - 50 Kg

- Optional stopper Soft-close per sistemi V-1860 / V-1863 / PO-290-BRIXIA
- Optional stopper with Soft-close mechanism for systems V-1860 / V-1863 / PO-290-BRIXIA
- Optional Stopper mit Soft-close für Systeme V-1860 / V-1863 / PO-290-BRIXIA

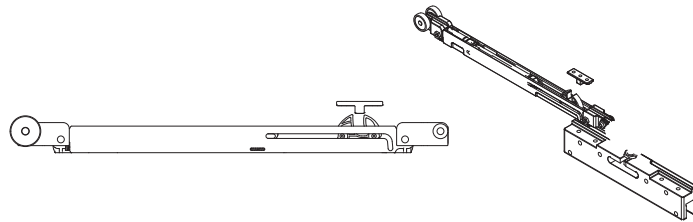

xme425i

€▶A.128

€▶A.129

V-1868

- Paio tappi finali per binario V-1860
- Pair endcaps for track profile V-1860
- Paar Endkappe für Laufschieneprofil V-1860

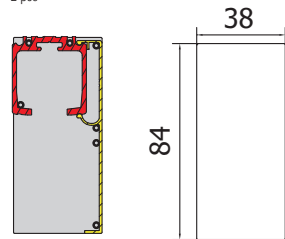

€▶A.131

282po40

V-1865

- Paio tappi finali per sistema V-1863
- Pair endcaps for system V-1863
- Paar Endkappe für System V-1863

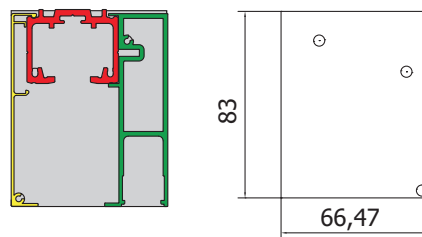

€▶A.134

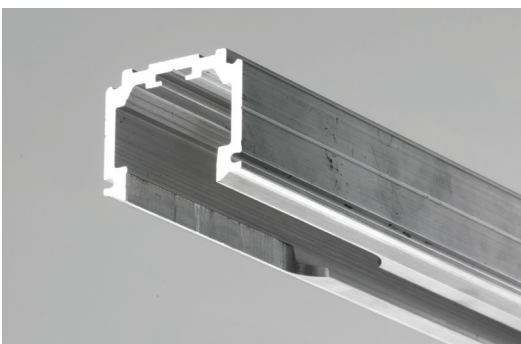

V-1815

- Binario Scorrevole con fresatura per inserimento carrelli e stopper Soft-close
- Track profile with recess for Soft-close stoppers and carriers in and out
- Laufschieneprofil mit Ausfräsung mit ein Ausfahren für Laufwerk und Soft-close stopper

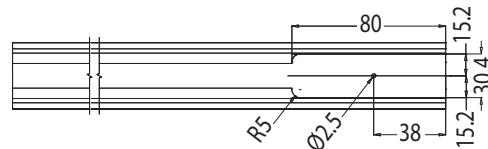
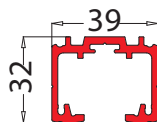

€▶A.236

xme425uv

PO-290-BRIXIA (OPTIONAL SOFT-CLOSE)

COMPONENTI / COMPONENTS / EINZELTEILE

SIMPLE

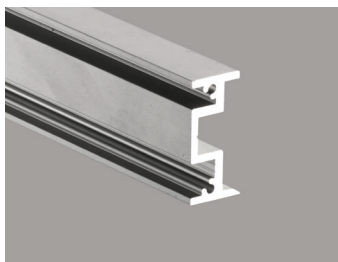

V-1827
 • Profilo a muro per PO-290 BRIXIA
 • Wall profile for PO-290 BRIXIA
 • Wandprofil für PO-290 BRIXIA
 AN

€▶A.140

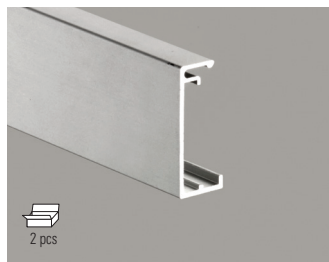
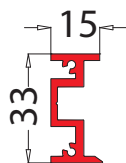

V-1829-CF2
 • Velella per binario V-1860 con anta PO-290-BRIXIA
 • Cover profile for track profile V-1860 with panel PO-290-BRIXIA
 • Abdeckung für Laufschienenprofil V-1860 mit Flügel PO-290-BRIXIA
 AN

€▶A.142

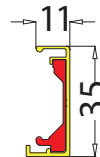

xme425i

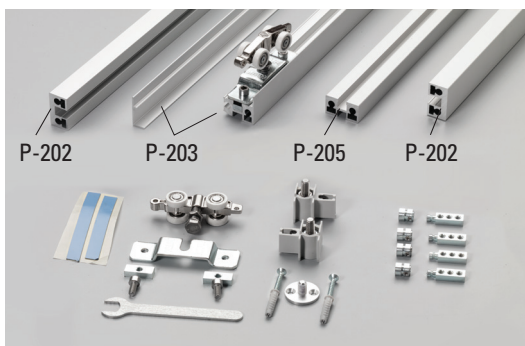

PO-290-BRIXIA
 • Profili per anta inteliata max 1200x3000 mm con carrelli e stopper
 • Profiles for aluminium panel max 1200x3000 mm with carriages and stoppers
 • Flügelrahmen aus Aluminium max 1200x3000 mm mit Laufwagen und stoppers
 AN

€▶A.139

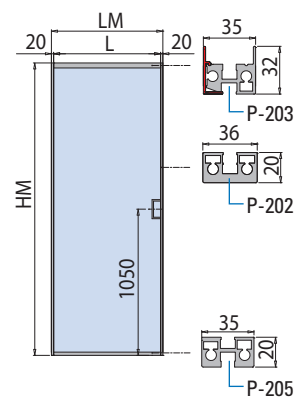

xme270ok



PO-290-TS4
 • Profili per anta inteliata max 1200 x 3000 mm con staffe
 • Profiles for aluminium panel max 1200x3000 mm, brackets included
 • Flügelrahmen aus Aluminium max 1200x3000 mm mit Winkelverbinder enthalten
 AN

€▶A.155

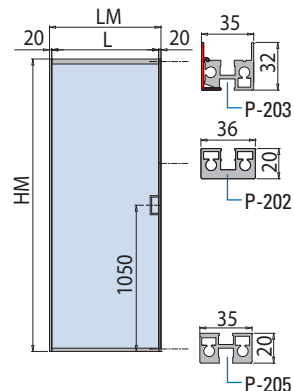

xme270ok

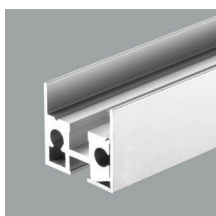

P-203
 • Traverso orizzontale superiore
 • Top horizontal profile
 • Oberes horizontalprofil
 AN

€▶A.145
 €▶A.148

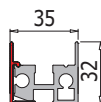

xme270a



P-202
 • Montante verticale
 • Vertical profile
 • Vertikalprofil
 AN

€▶A.144
 €▶A.147

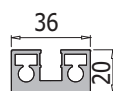

xme270a

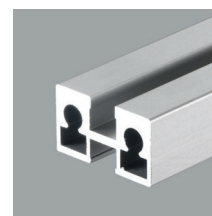

P-205
 • Traverso orizzontale inferiore
 • Bottom horizontal profile
 • Unterer horizontalprofil
 AN

€▶A.146
 €▶A.148

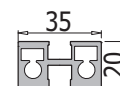

xme270a

P-F25

- Ferramenta necessaria per assemblare n.1 anta intelaiata PO-290.
- Fixing materials to assembly one aluminium panel PO-290.
- Befestigungsmaterial für 1 set Flügelrahmen PO-290.

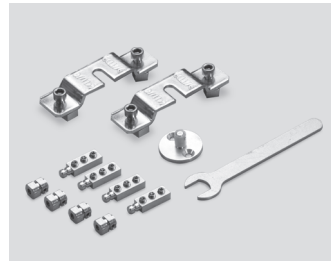
A.153

PO-292-TS4

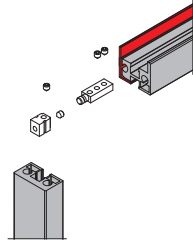
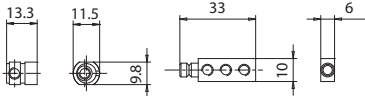
- Set accessori per 1 anta scorrevole intelaiata composto da:
N° 2 staffe - N° 4 connettori profili anta - N° 1 oliva a pavimento
- Accessory set for 1 sliding door with aluminium panel containing:
N° 2 brackets, N° 4 connectors for profiles, N° 1 floor guide
- Zubehör Set komplett für 1 Schiebetür mit Aluminium Flügelrahmen bestehend aus:
N° 2 Verbinder für Laufwagen, N° 4 Verbinder für Profile, N° 1 Bodenführung

A.155

xme270

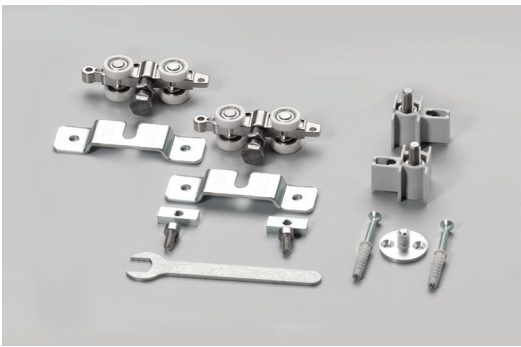

SIMPLE

PO-292-BRIXIA

- Set accessori per 1 anta scorrevole intelaiata composto da: n.2 carrellini n.2 stoppers - n.1 oliva a pavimento.
- Accessory set for 1 sliding door with aluminium panel containing: N° 2 carriers N° 2 stoppers N° 1 floor guide.
- Zubehör Set komplett für 1 Schiebetür mit Aluminium Flügelrahmen bestehend aus: N° 2 Laufwagen N° 2 Stopper N° 1 Bodenführung.

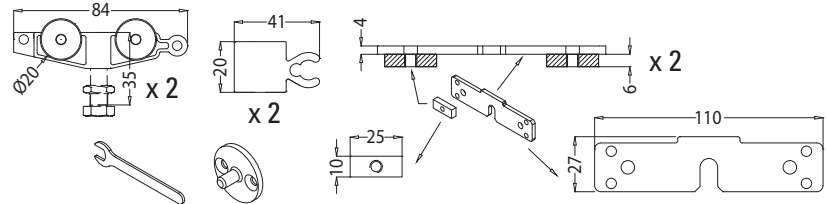
A.151

xme503

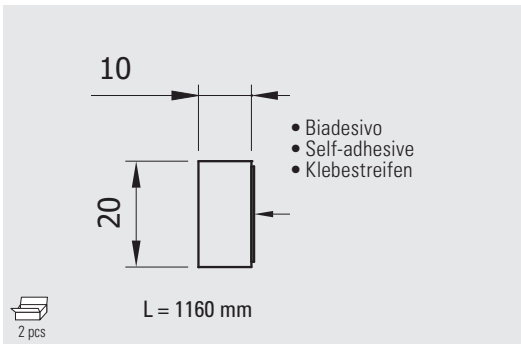
P-204-CF2

- Traversino orizzontale per anta intelaiata in alluminio PO-200/PO-290, da incollare al vetro con biadesivo in dotazione. Prezzo a confezione di 2 barre L=1160 mm
- Horizontal cross profile with self-adhesive for aluminium panel PO-200/PO-290. Price each package unit of 2 bars L=1160 mm
- Horizontal Querprofil selbstklebend für Flügelrahmen aus Aluminium PO-200/PO-290. Preis pro VE von 2 Stangen L=1160 mm

A.152

AN

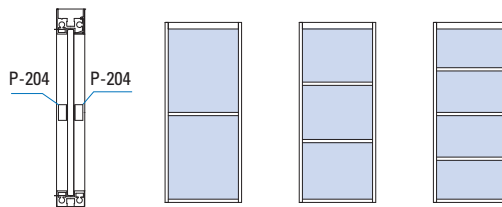

xfb-045

F-007

- Paio maniglie ad incollaggio in alluminio anodizzato naturale
- Pair sliding handle with self adhesive fixing in anodised aluminium
- Paar Schiebegriffe aus eloxiertem Aluminium Selbstklebend

AN

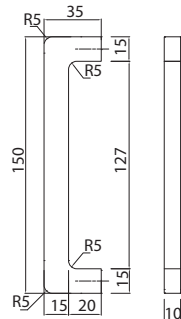
A.141

F-007

V-1818-P

- Paio tappi finali per sistema PO-290-BRIXIA
- Pair endcaps for system PO-290-BRIXIA
- Paar Endkappe für System PO-290-BRIXIA

AN

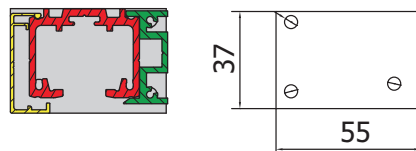

2 pcs

A.143

282po41