

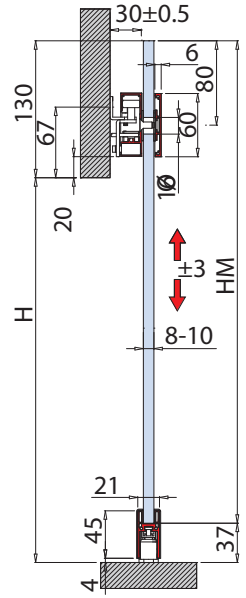

# MOOVI SOFT-CLOSE

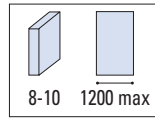

## V-8200



$$HM = H + (130 - 37)$$

### V-8200 SET 1

€▶A.321

- Set per 1 anta scorrevole, fissaggio a parete
- Sliding door set, wall installation
- Schiebetürset 1-flügelig, Wandmontage

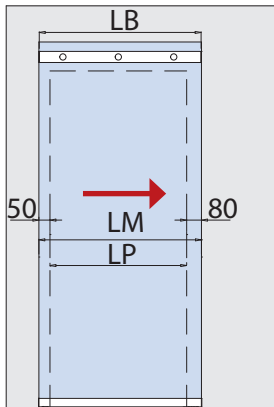

$$LM = LP + (80 + 50)$$

$$LB = LM - 4$$

### V-8200 SET 2

€▶A.322

- Set per 2 ante scorrevoli, fissaggio a parete
- Sliding doors set, wall installation
- Schiebetürset 2-flügelig, Wandmontage

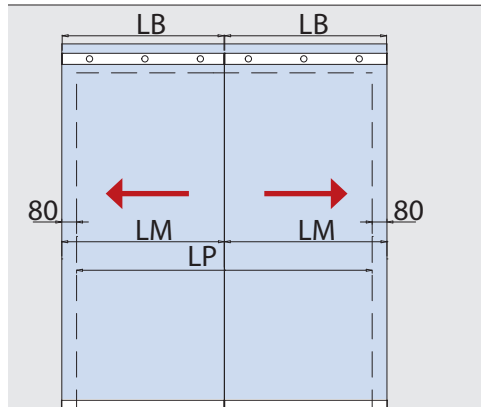

$$LM = LP + (80 + 80) / 2$$

$$LB = LM - 4$$

### LAVORAZIONE VETRO GLASS PREPARATION GLASBEARBEITUNG

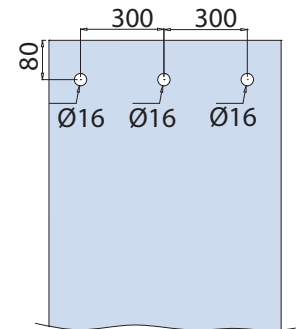

xme525B

## COMPONENTI / COMPONENTS / EINZELTEILE ▶ 102

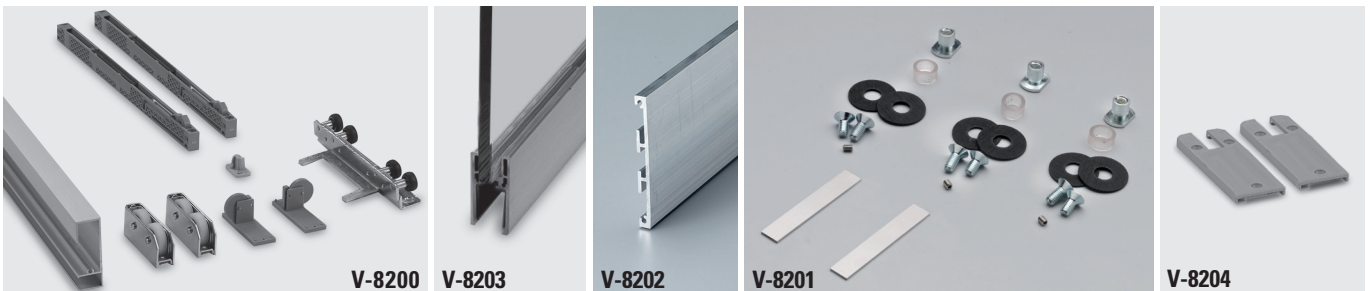

Cod.	Fin. / Fin. / Oberf.	V-8200 SET 1 FIX	V-8200 SET 2 FIX
V-8200 L=1192 mm	AN	1	2
V-8203 L=1200 mm	AN / IXE	1	2
V-8202 L=1196 mm	AN / IXE	1	2
V-8201	AN / NS	1	2
V-8204	AN / IXE	1	2



# MOOVI SOFT-CLOSE



## V-8250

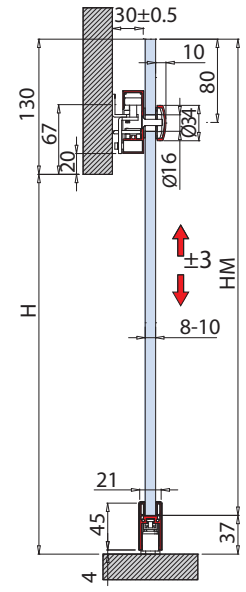
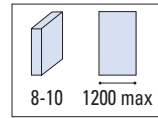

$$HM = H + (130 - 37)$$

### V-8250 SET 1

€▶A.323

- Set per 1 anta scorrevole, fissaggio a parete
- Sliding door set, wall installation
- Schiebetürset 1-flügelig, Wandmontage

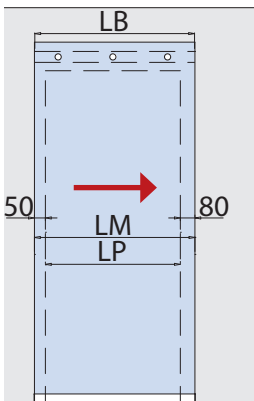

$$LM = LP + (80 + 50)$$

$$LB = LM - 4$$

### V-8250 SET 2

€▶A.324

- Set per 2 ante scorrevoli, fissaggio a parete
- Sliding doors set, wall installation
- Schiebetürset 2-flügelig, Wandmontage

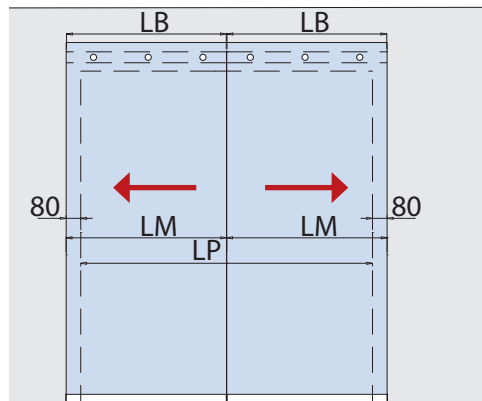

$$LM = LP + (80 + 80) / 2$$

$$LB = LM - 4$$

### LAVORAZIONE VETRO GLASS PREPARATION GLASBEARBEITUNG

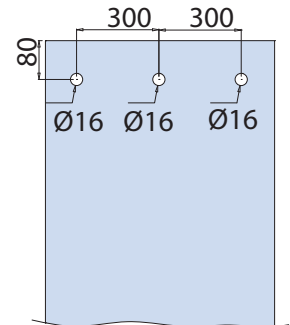

TECHNICAL

xme525A

## COMPONENTI / COMPONENTS / EINZELTEILE ▶ 102

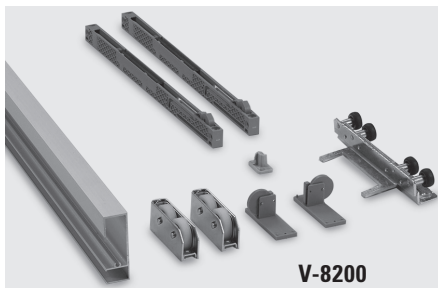

V-8200

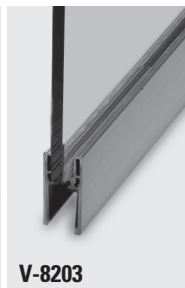

V-8203



V-8251



V-8204

Cod.	Fin. / Fin. / Oberf.	V-8250 SET 1 FIX	V-8250 SET 2 FIX
V-8200 L=1192 mm	AN	1	2
V-8203 L=1200 mm	AN / IXE	1	2
V-8251	AN / NS	1	2
V-8204	AN / IXE	1	2

# V-8200 / V-8250 MOOVI SOFT-CLOSE

## COMPONENTI / COMPONENTS / EINZELTEILE

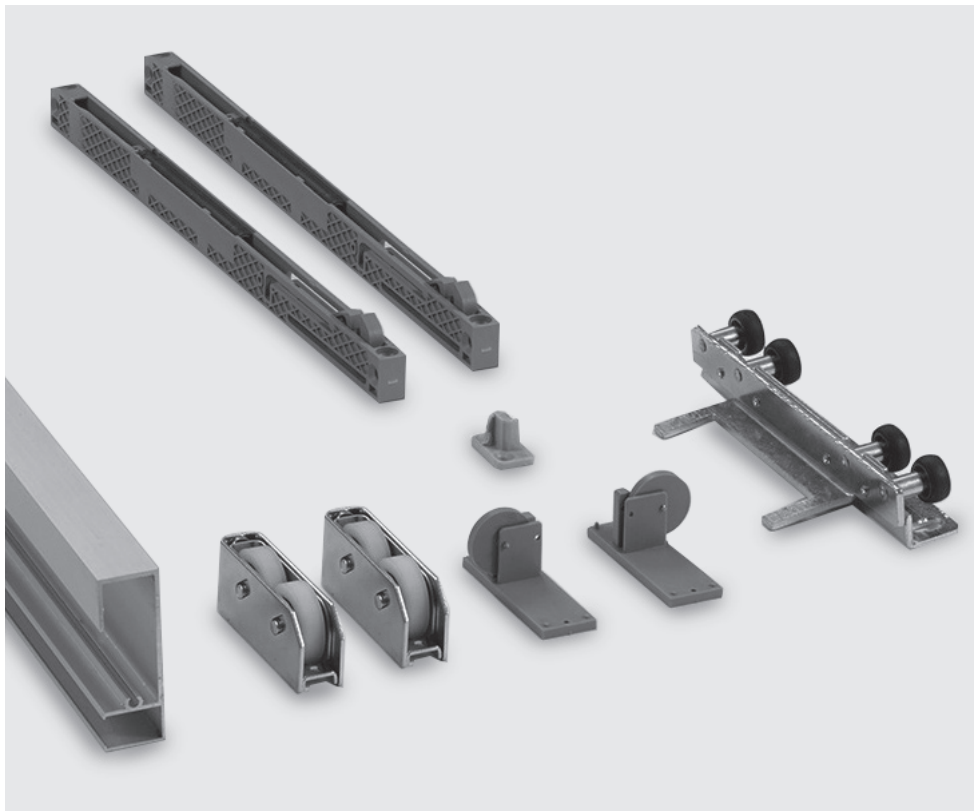

### V-8200

€▶A.325

- Set accessori per 1 anta scorrevole per sistema V-8200 e V-8250
  - Accessories set for 1 sliding panel for systems V-8200 and V-8250
  - Zubehör für 1 Schiebetür für V-8200 und V-8250
- AN - IXE

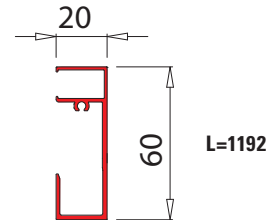

TECHNICAL

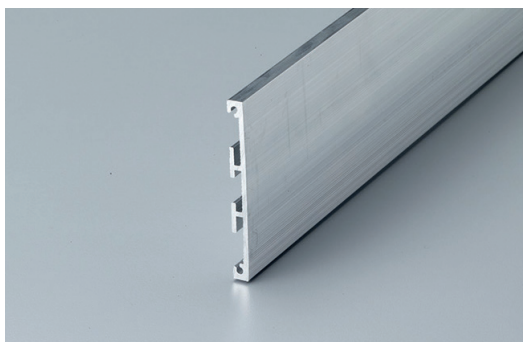
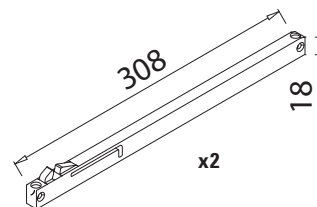
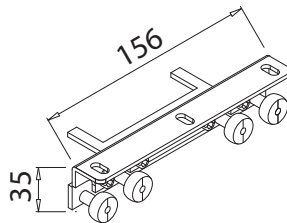
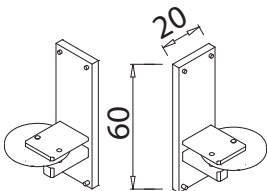
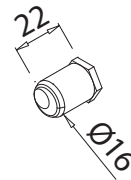
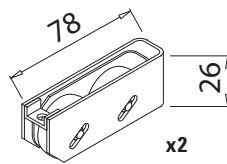
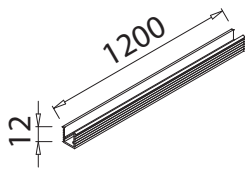

### V-8202

- Veletta per binario
  - Cover profile for track profile
  - Profilabdeckung für Laufschiene
- AN - IXE

€▶A.327

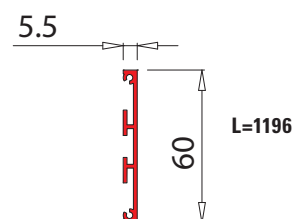

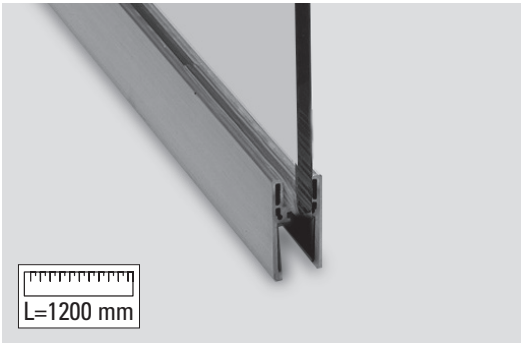

**V-8203**

€▶A.326

- Profilo inferiore compreso di guarnizione
  - Bottom profile with gasket
  - Unteres Profil mit Dichtung
- AN - IXE

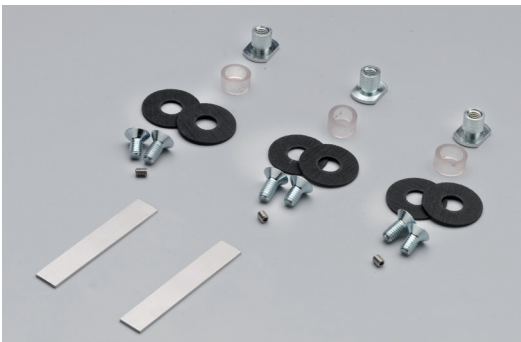
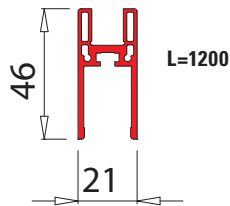

**V-8201**

€▶A.328

- Set 3 pz punti di fissaggio per 1 anta e tappi laterali per veletta V-8202
  - Set 3 pcs fixing points for 1 panel and endcaps for cover profile V-8202
  - Set 3 Stk Punkthalterungen für 1 Flügel und Endkappen für Abdeckung V-8202
- AN - NS

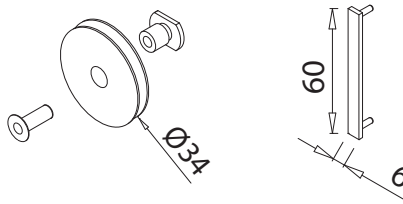

TECHNICAL



**V-8251**

€▶A.330

- Set 3 pz punti di fissaggio per 1 anta per sistema V-8250
  - Set 3 pcs fixing points for 1 panel for system V-8250
  - Set 3 Stk Punkthalterungen für 1 Flügel für System V-8250
- AN - NS

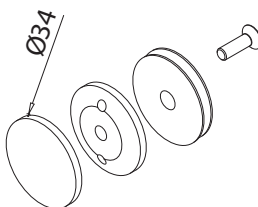

2 pcs

**V-8204**

€▶A.329

- Paio tappi per profilo inferiore V-8203
- Pair endcaps for bottom profile V-8203
- Paar Endkappen für unteres Profil V-8203

