

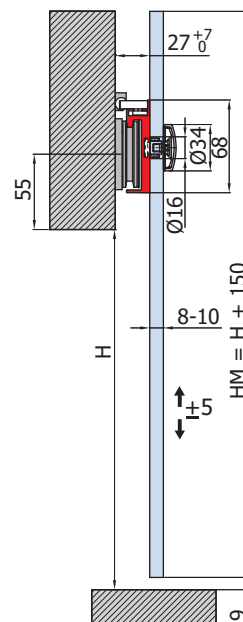

# INDEPENDENT

## V-8000

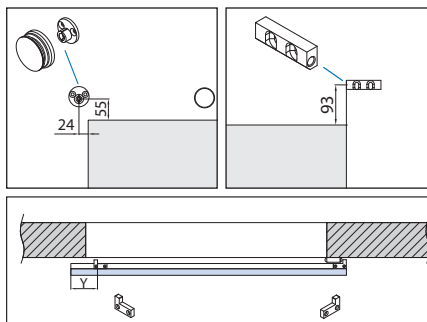
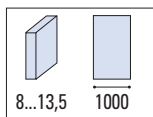

### V-8000 SET 1

€▶A.333

- Set per 1 ante scorrevole, fissaggio a parete
- Sliding door set, wall installation
- Schiebetürset 1-flügelig, Wandmontage

### V-8000 SET 2

€▶A.334

- Set per 2 ante scorrevoli, fissaggio a parete
- Sliding doors set, wall installation
- Schiebetürset 2-flügelig, Wandmontage

LAVORAZIONE VETRO  
GLASS PREPARATION  
GLASBEARBEITUNG

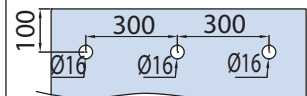

TECHNICAL

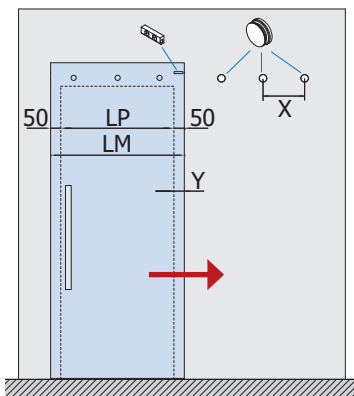

$$LM = LP + 100$$

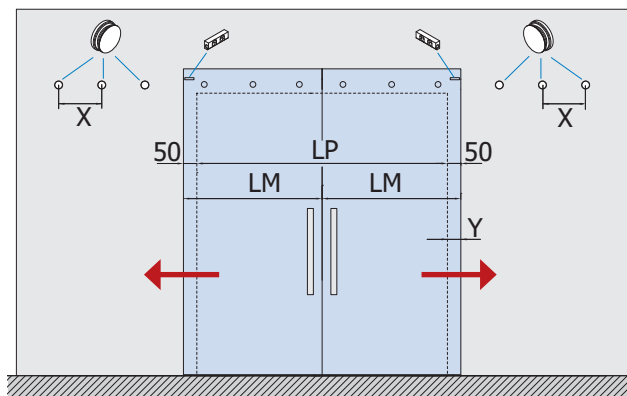

$$LM = (LP + 100) / 2$$

xme249a

## COMPONENTI / COMPONENTS / EINZELTEILE ▶ 110



| Cod.                        | Fin. / Fin. / Oberf. | V-8000 SET 1     | V-8000 SET 2     |
|-----------------------------|----------------------|------------------|------------------|
| <b>V-8000</b> L=1000 L=1400 | IXE                  | 1                | 2                |
| <b>V-8001</b>               | NS / CR              | 1                | 2                |
| <b>V-8002</b>               | NS / CR              | 1                | 2                |
| <b>V-012</b>                | NS / CR              | 1                | 2                |
| <b>V-8005</b> L= >1100      |                      | 1 extra x 140 mm | 1 extra x 140 mm |

# V-8000 / V-8100 / V-8050 / V-8040 INDEPENDENT COMPONENTS / COMPONENTS / EINZELTEILE



**V-8000** €▶A.341

- Binario Independent
- Independent track profile
- Laufschiene Independent

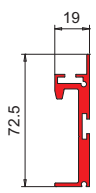

| Cod.           | Fin. / Fin. / Oberf. |
|----------------|----------------------|
| V-8000-1000 mm | IXE                  |
| V-8000-1400 mm | IXE                  |

xfb-064

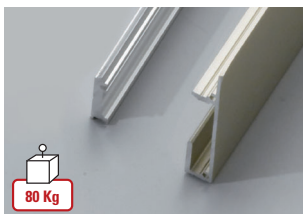

**V-8100** €▶A.342

- Veletta per binario Independent
- Cover profile for Independent track profile
- Profilabdeckung für Laufschiene Independent

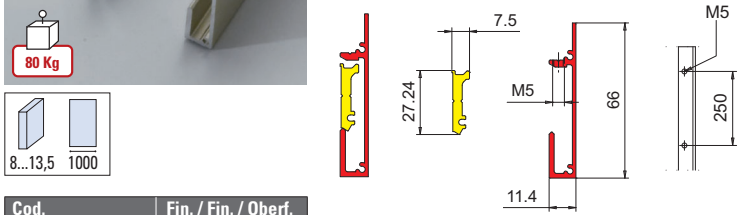

| Cod.           | Fin. / Fin. / Oberf. |
|----------------|----------------------|
| V-8100-1000 mm | IXE / CR             |
| V-8100-1400 mm | IXE / CR             |

xfb-064



**V-8002** €▶A.343

- Set 7 pz ruote di scorrimento e stopper per 1 anta
- Set 7 pcs rollers and stopper for 1 panel
- Set 7 Stk Laufrollen und Stopper für 1 Flügel

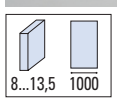

**V-8005** €▶A.345

- Ruota di scorrimento
- Roller
- Laufrolle

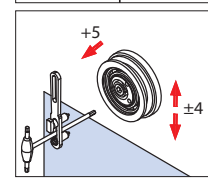
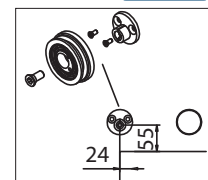
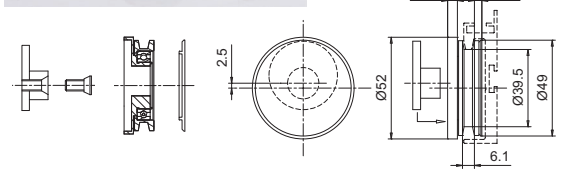

xfb-064

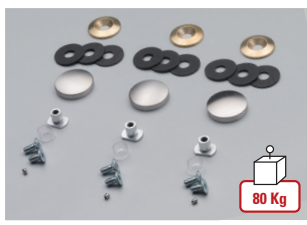

**V-8001** €▶A.344

- Set 3 pz punti di fissaggio per 1 anta per sistema V-8000
- Set 3 pcs fixing points for 1 panel for system V-8000
- Set 3 Stk Punkthalterungen für 1 Flügel für System V-8000

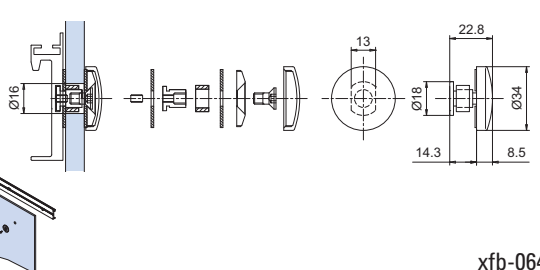
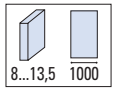

xfb-064



**V-8051** €▶A.346

- Set 3 pz punti di fissaggio per 1 anta per sistema V-8050
- Set 3 pcs fixing points for 1 panel for system V-8050
- Set 3 Stk Punkthalterungen für 1 Flügel für System V-8050

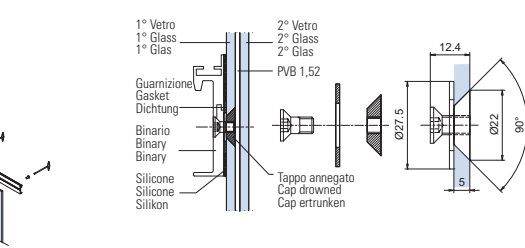
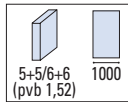

xfb-064



**V-8101** €▶A.345

- Set 3 pz punti di fissaggio per 1 anta e tappi laterali per veletta V-8100
- Set 3 pcs fixing points for 1 panel and endcaps for cover profile V-8100
- Set 3 Stk Punkthalterungen für 1 Flügel und Endkappen für Abdeckung V-8100

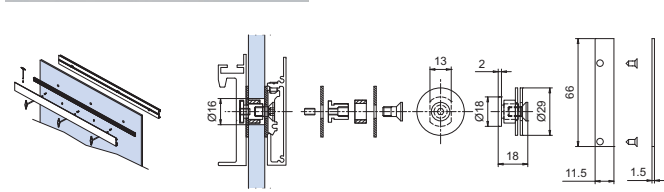

xfb-064



**V-8006** €▶A.349

- Stopper per 1 anta
- Stopper for 1 panel
- Stopper für 1 Flügel

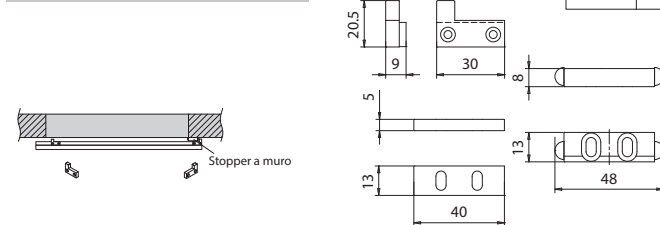

xfb-064

TECHNICAL