

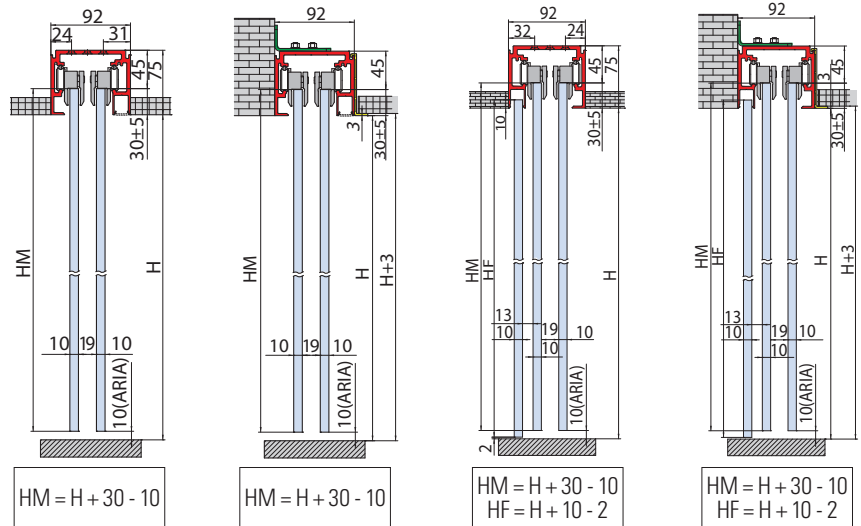

INVISIBILE DOPPIO TELESCOPICO V-7200

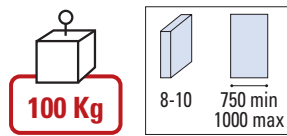

Le formule per la "larghezza vetri" sono uguali, sia per il sistema invisibile che per il sistema "a vista"; cambiano solo le formule per l'altezza.
Calculations for "glass width" are the same for invisible or visible installation.
Die Berechnungen der "Glasbreite" sind für sichtbare und unsichtbare Befestigungen der Laufschiene gleich.

V-7200 SET 1 €▶A.472

- Sistema per 2 ante scorrevoli telescopiche con possibilità di vetro fisso, con kit di trascinamento, fissaggio a soffitto
- Telescopic sliding door system 2-ways and optional fixed panel, with dragging mechanism, ceiling installation
- Teleskopisches Schiebetürsystem 2-läufig mit optional Seitenteil, mit Mitnehmer Kit, Deckenmontage

V-7200 SET 1 • Soffitto • Ceiling • Decke
V-7200 SET 2 • Parete • Wall • Wand

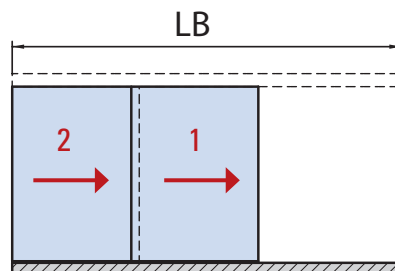
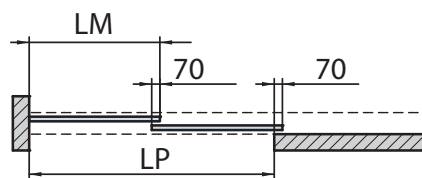

$$LB = LP + LM + 150$$

$$LM = (LP + 140) / 2$$

V-7200 SET 1 • Soffitto • Ceiling • Decke
V-7200 SET 2 • Parete • Wall • Wand

Con vetro fisso / With fixed panel / Mit Seitenteil

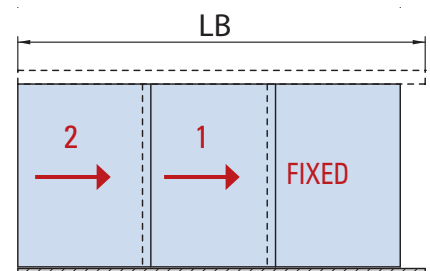
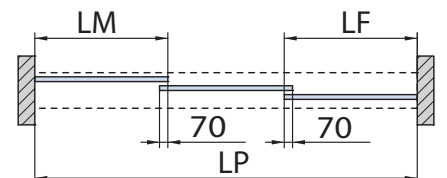

$$LB = LP$$

$$LM = LF = (LP + 140) / 3$$

V-7200 SET 2 €▶A.473

- Sistema per 2 ante scorrevoli telescopiche con possibilità di vetro fisso, con kit di trascinamento, fissaggio a parete
- Telescopic sliding door system 2-ways and optional fixed panel, with dragging mechanism, wall installation
- Teleskopisches Schiebetürsystem 2-läufig mit optional Seitenteil, mit Mitnehmer Kit, Wandmontage

TELESCOPIC

COMPONENTI / COMPONENTS / EINZELTEILE ▶ 132

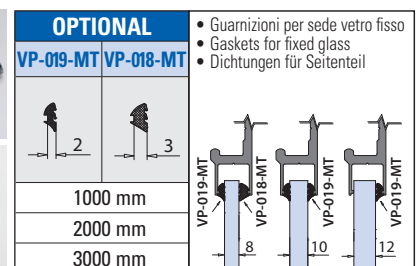



"A VISTA"

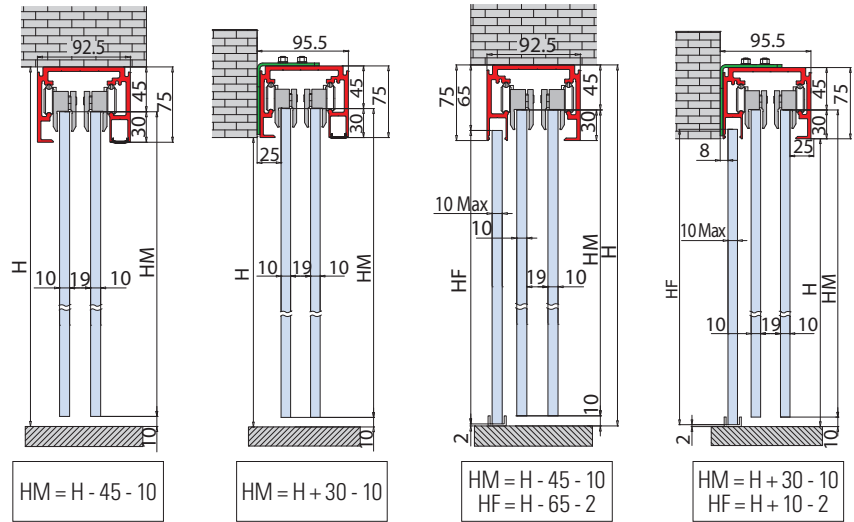

V-7200 SET 5 €▶A.474

- Sistema per 2 ante scorrevoli telescopiche libere, fissaggio a soffitto
- Telescopic sliding door system 2-ways, for free movable panels, ceiling installation
- Teleskopisches Schiebetürsystem 2-läufig frei bewegliche, gegenläufige ganzglasschiebetüren Deckenmontage

V-7200 SET 5 • Soffitto • Ceiling • Decke

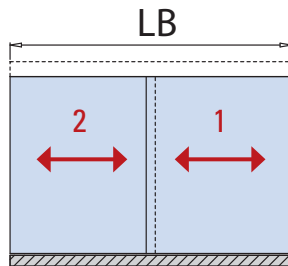
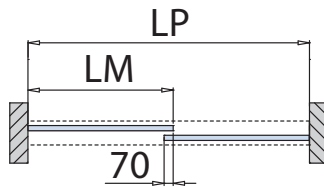

$LB = LP$
 $LM = (LP + 70) / 2$



TELESCOPIC

xla325d / xla325c / xme267

Cod.	Fin. / Fin. Oberf.	V-7200 SET 1 FIX	V-7200 SET 1-MIS	V-7200 SET 2 FIX	V-7200 SET 2-MIS	V-7200 SET 5 FIX	V-7200 SET 5-MIS
V-7200 LB = 2000 LB = 3000 LB = 4000 LB = 6000	AN	1	-	1	-	1	-
V-7200-MIS L = 1500 → 6000	AN	-	1	-	1	-	1
V-7202	-	1	1	1	1	1	1
V-7206	-	1	1	1	1	-	-
V-7005 Staffa / Bracket / Winkelverbinder	-	-	-	1 x 400 mm	1 x 400 mm	-	-
V-012-INS	AN	-	-	-	-	2	2
V-7201 Tappi / Endcaps / Endkappe	AN	-	-	1	1	-	-

V-7200 INVISIBILE DOPPIO TELESCOPICO

COMPONENTI / COMPONENTS / EINZELTEILE



V-7200

- Binario telescopico "Invisibile doppio"
- Telescopic track profile "Invisibile doppio"
- Laufschiene Teleskopisch "Invisibile doppio"

AN

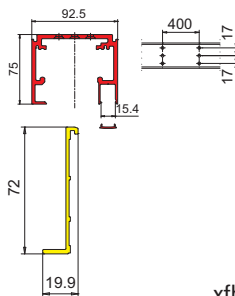

xfb-070

V-7006-CF2

- Profilo per V-7200 con appoggio per controsoffitto.
- Profile for V-7200 with support for suspended ceiling.
- Profil für V-7200 mit Auflage für Abgehängter Decke.

AN



V-7202

- Set accessori per 2 ante scorrevoli "Invisibile doppio":
4 carrelli morsetti per vetro 8-10 mm, 4 stopper
- Accessory set for 2 "Invisibile doppio" sliding panels:
4 roller carriers for glass 8-10 mm, 4 endstops
- Zubehör Set für 2 "Invisibile doppio" Schiebetüren:
4 klemm-Laufwagen für Glas 8-10 mm, 4 Stopper

100 Kg

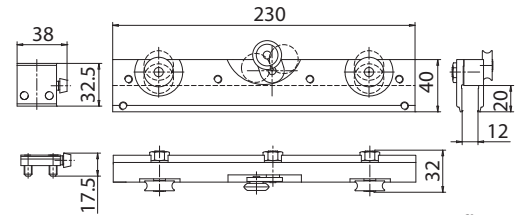
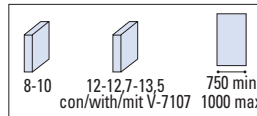

xfb-070



V-7206

- Kit morsetti trascinamento meccanico per 2 ante scorrevoli compreso di guide a pavimento V-012 e guida doppia V-099-B
- Dragging kit for 2 sliding panel, including floor guides V-012 and double floor guide V-099-B
- Mitnehmer Set für 2 bewegliche Schiebetüren mit Bodenführungen V-012 und V-099-B

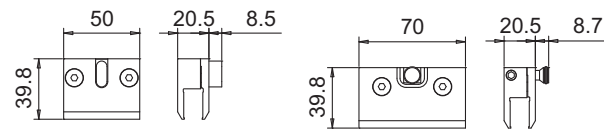

xfb-070

OPTIONAL	
VP-019-MT	VP-018-MT
1000 mm	
2000 mm	
3000 mm	
<ul style="list-style-type: none"> • Guarnizioni per sede vetro fisso • Gaskets for fixed glass • Dichtungen für Seitenteil 	
8	10
12	

OPTIONAL

V-7009

- Staffa per fissaggio a parete, applicazione "a vista" (circa 1 pezzo ogni 400 mm)
- Bracket for wall installation, "visible" installation (about 1 pieces each 400 mm)
- Stück Winkelprofil für Wandmontage, "sichtbare Installation" (1 Stück je ca. 400 mm)

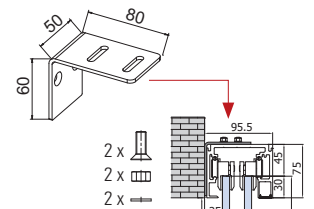

xfb-070 / xla325b



V-7005

- Staffa per fissaggio a parete (circa 1 pezzo ogni 400 mm)
- Bracket for wall installation (about 1 pieces each 400 mm)
- Stück Winkelprofil für Wandmontage (1 Stück je ca. 400 mm)

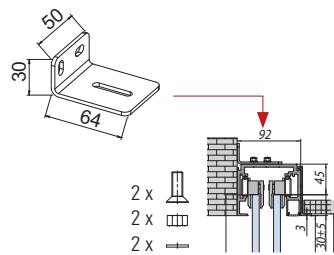

xfb-070

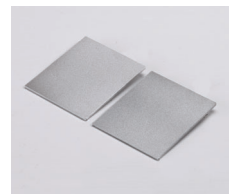

V-7201

- Paio tappi finali in alluminio per guida di scorrimento V-7200
- Pair aluminium endcaps for track profile V-7200
- Paar Endkappen aus Aluminium für Laufschiene V-7200

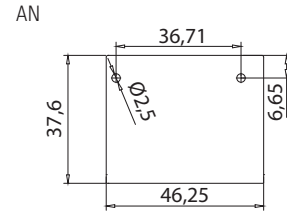

xfb-070

V-2014-MIX

- Canalina per vetro fisso escluso guarnizioni
- U channel for fixed panel, gaskets not included
- U Profil für Seitenteil Dichtungen nicht inkl.

AN - IXE

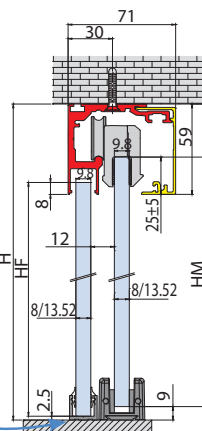
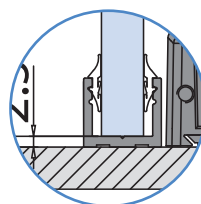

- Profilo da infilare
- Insert profile
- Profil durchziehen

- Guarnizioni
- Gaskets
- Dichtungen

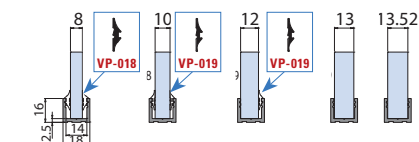

Cod.	Fin./Fin./Oberf.
V-2014-2000 mm	AN / IXE / NO
V-2014-3000 mm	AN / IXE / NO
V-2014-6000 mm	AN / IXE / NO

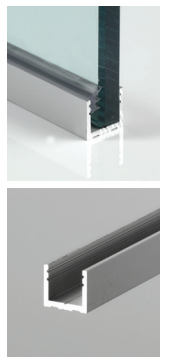

FB044-E