

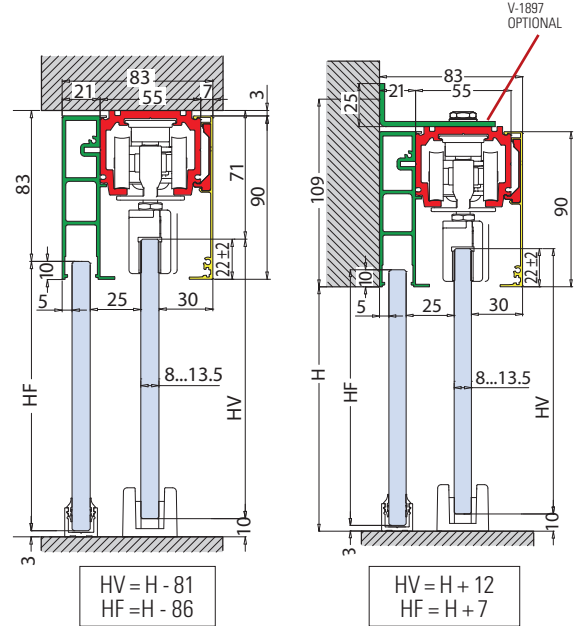

## BRIXIA 140 (OPTIONAL SOFT-CLOSE)

### V-1893

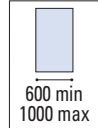
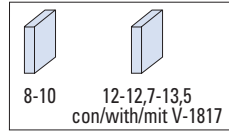

SIMPLE

### V-1893 SET 1

€▶A.168

- Set per 1 anta scorrevole e vetro fisso, fissaggio a parete/soffitto
- Sliding door set with fixed panel, wall/ceiling installation
- Schiebetürset 1-flügelig mit Seitenteil, Wand-Deckenmontage

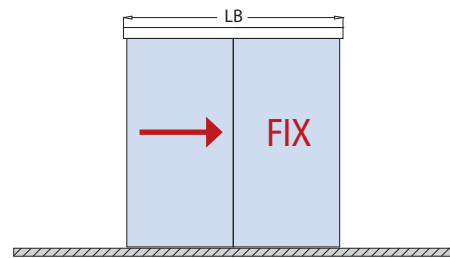

### V-1893 SET 2

€▶A.169

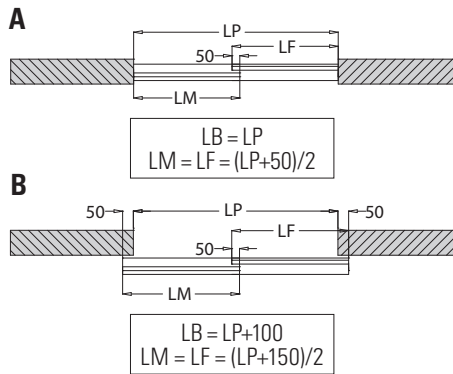

### LAVORAZIONE VETRO GLASS PREPARATION GLASBEARBEITUNG

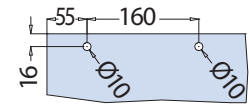

OPTIONAL (x 2)

- **ATTENZIONE:** Con fori di sicurezza **optional** l'anta minima con soft-close aumenta di 100mm
- **WARNING:** With **optional** security holes min. panel's width soft-close must be increased of 100mm
- **ACHTUNG:** Wenn **optionale** Sicherheitsbohrungen und Soft-close eingesetzt werden, muss die Mindestbreite um 100mm verlängert werden

xme431b

## COMPONENTI / COMPONENTS / EINZELTEILE ▶ 62

<b>V-1890</b>	<b>V-1894</b>	<b>V-1892</b>	<b>V-1899</b>	<b>V-012</b>	<b>V-1896-140 (OPTIONAL)</b> -140 Kg	<b>V-1896-100 (OPTIONAL)</b> -100 Kg	<b>V-1899</b>	<b>V-012</b>
	<b>V-1632</b>	<b>V-1824-140 (OPTIONAL)</b> -140 Kg	<b>V-1824-100 (OPTIONAL)</b> -100 Kg		600 min 1 pcs	950 min 2 pcs		

**V-1896-140 (OPTIONAL)**-140 Kg

**V-1896-100 (OPTIONAL)**-100 Kg

**V-1899**

**V-012**

OPTIONAL		Guarnizioni per sede vetro fisso	
VP-019-MT	VP-018-MT	Gaskets for fixed glass	Dichtungen für Seitenteil
2	3		
1000 mm			
2000 mm			
3000 mm			

Cod.	Fin. / Fin. / Oberf.	V-1893 SET 1 FIX	V-1893 SET 1 MIS	V-1893 SET 2 FIX	V-1893 SET 2 MIS
<b>V-1890</b> LB=2000 LB=3000 LB=4000 LB=6000	AN	1	—	1	—
<b>V-1890-MIS</b> LB= 1500→6000	AN	—	1	—	1
<b>V-1632</b> LB=2000 LB=3000 LB=4000 LB=6000	AN/IXE	1	—	1	—
<b>V-1632-MIS</b> LB= 1500→6000	AN/IXE	—	1	—	1
<b>V-1894</b> LB=2000 LB=3000 LB=4000 LB=6000	AN	1	—	1	—
<b>V-1894-MIS</b> LB= 1500→6000	AN	—	1	—	1
<b>V-1892</b>	—	1	1	2	2
<b>V-1896-140</b> Soft-close (OPTIONAL)	—	(1)	(1)	(2)	(2)
<b>V-1896-100</b> Soft-close (OPTIONAL)	—	(1)	(1)	(2)	(2)
<b>V-1824-140</b> Soft-close (OPTIONAL)	—	(1) (2)	(1) (2)	(2) (4)	(2) (4)
<b>V-1824-100</b> Soft-close (OPTIONAL)	—	(1) (2)	(1) (2)	(2) (4)	(2) (4)
<b>V-1899</b>	AN	1	1	1	1
<b>V-012</b>	AN/IXE	1	1	2	2
<b>V-1897</b> Staffa / Bracket / Winkelverbinder (OPTIONAL)		1 x 400 mm	1 x 400 mm	1 x 400 mm	1 x 400 mm

# V-1890 / V-1893 BRIXIA 140 (OPTIONAL SOFT-CLOSE)

## COMPONENTI / COMPONENTS / EINZELTEILE

SIMPLE

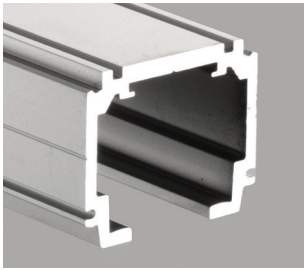

### V-1890

- Binario Scorrevole BRIXIA 140
  - Track profile BRIXIA 140
  - Laufschieneprofil BRIXIA 140
- AN

€▶A.170

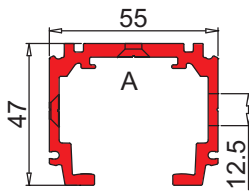
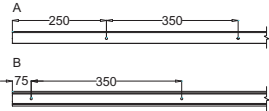

xme431c

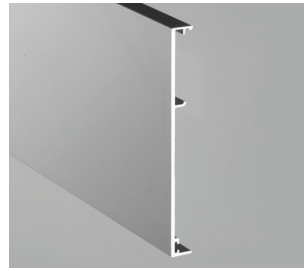

### V-1632 H

- Veletta per binario V-1890
  - Cover profile for Track profile V-1890
  - Abdeckung für Laufschiene V-1890
- AN

€▶A.171



xme431c



### V-1894

- Profilo per vetro fisso BRIXIA 140
  - Side panel profile BRIXIA 140
  - Seitenteilprofil BRIXIA 140
- AN

€▶A.172

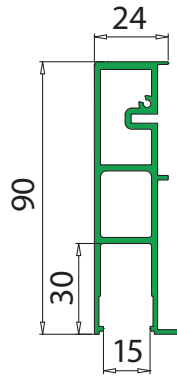

xme431c

OPTIONAL €▶A.187	
VP-019-MT	VP-018-MT
2	3
1000 mm - 2000 mm - 3000 mm	
<ul style="list-style-type: none"> <li>• Guarnizioni per sede vetro fisso</li> <li>• Gaskets for fixed glass</li> <li>• Dichtungen für Seitenteil</li> </ul>	
8	10
12	

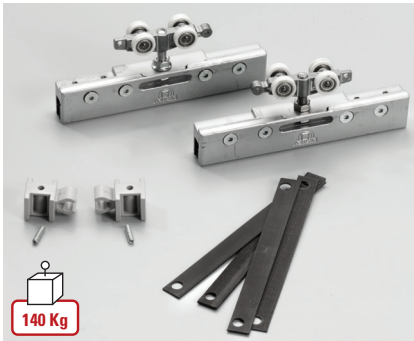

### V-1892

- Set accessori per 1 anta scorrevole composto da 2 carrelli, morsetti per vetro 8-10 mm. 2 stoppers
- Accessories set for 1 sliding panel consisting of N°2 trolley hangers with clamp carriage for 8/10 mm glass. N°2 endstops
- Zubehör für 1 Schiebetür bestehend aus: N°2 Klemm - Laufwagen für 8/10 mm Glas. N°2 Stopper

€▶A.173

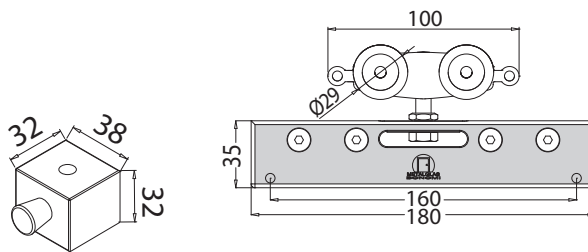

xme431c

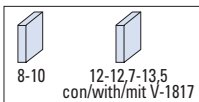

### V-090

- Pinza
- Clamp
- Klemmschuh

€▶A.178

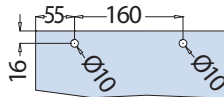

- Fori optional
- Holes optional
- Bohrungen Optional

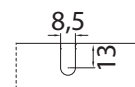
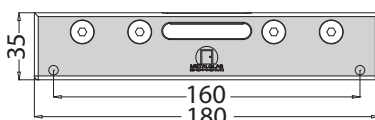

xme431c / xme425a

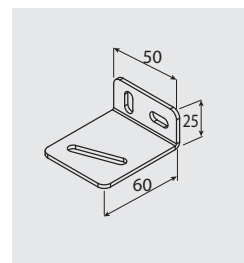

### V-1867

- Staffa per fissaggio a parete per sistema V-1863 (circa 1 pezzo ogni 400 mm)
- Angled profile for wall installation for system V-1863 (about 1 piece every 400 mm)
- Winkelverbinder für Wandmontage System V-1863 (1 Stück je ca 400 mm)

€▶A.135

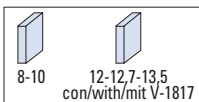

**V-1896-140 Kg**  
**V-1896-100 Kg**

- 1 pcs soft-close double

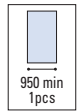
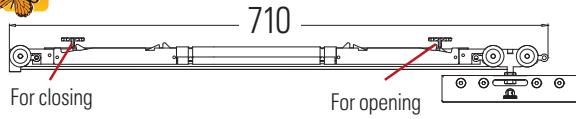

xme431c

€▶A.177 €▶A.176

**V-1824-140 Kg**  
**V-1824-100 Kg**

- 1 pcs Soft-close

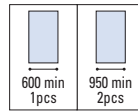
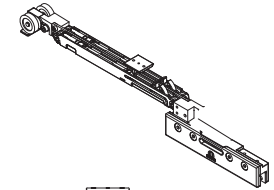

xme431c

€▶A.175

€▶A.174

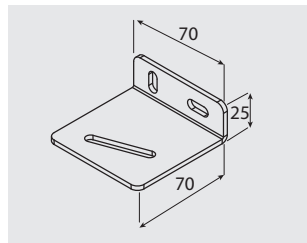

SIMPLE

**V-1897**

- Staffa per fissaggio a parete binario V-1890 e profilo per fisso V-1894 (circa 1 pezzo ogni 400 mm)
- Winkelverbinder für Wandmontage Laufschiene V-1890 und Seitenteilprofil V-1894 (1 Stück je ca 400 mm)
- Angled profile for wall installation track profile V-1890 and side panel profile V-1894 (about 1 piece every 400 mm)

€▶A.186

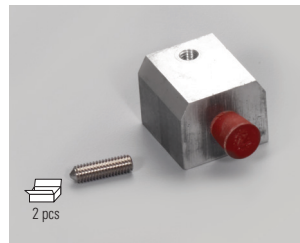
**V-1891**

- Stoppers Brixia 140 Kg

€▶A.181

xme425c

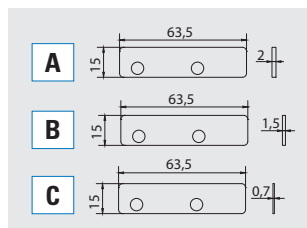
**V-1817-A**  
**V-1817-B**  
**V-1817-C**

- Kit spessori per vetro 12 - 12,7 - 13,5 per 2 pinze V-090 e V-090-T
- Kit spacers for glass thickness 12 - 12,7 - 13,5 for 2 clamps V-090 and V-090-T
- Kit Distanzscheiben für Glasdicke 12 - 12,7 - 13,5 für 2 Klemm-Lauwagen V-090 und V-090-T

€▶A.179

**V-1895**

- Carrello Brixia 140 Kg
- Carrier Brixia 140 Kg
- Laufwagen Brixia 140 Kg

€▶A.180

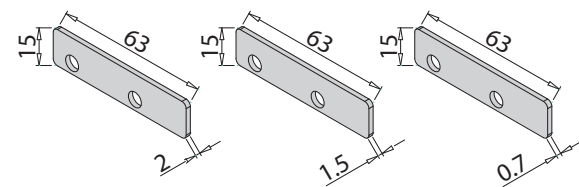

xme425t

xme425i

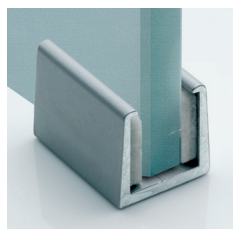
**V-012**

- Guida a pavimento per scorrevole con feltrini per vetro 8 e 10 mm
  - Floor guide with felt strips for glass sliding door a 8 and 10mm
  - Bodenführung mit Filzgleiter für Glas 8 und 10 mm
- AN - NS - CR

€▶A.182

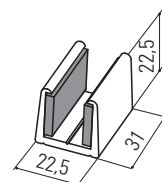

v-012

**V-1898**

- Paio tappi finali per sistema V-1890
- Pair endcaps for system V-1890
- Paar Endkappe für System V-1890

AN

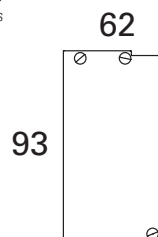

€▶A.184

**V-1899**

- Paio tappi finali per sistema V-1893
- Pair endcaps for system V-1893
- Paar Endkappe für System V-1893

AN

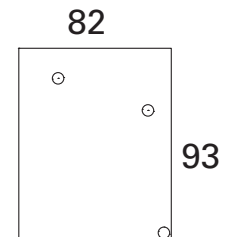

€▶A.185