

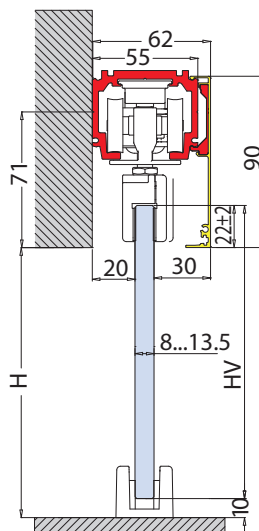

BRIXIA 140 (OPTIONAL SOFT-CLOSE)

V-1890

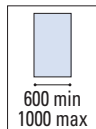
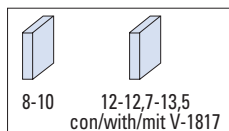

$$HV = H + 12$$

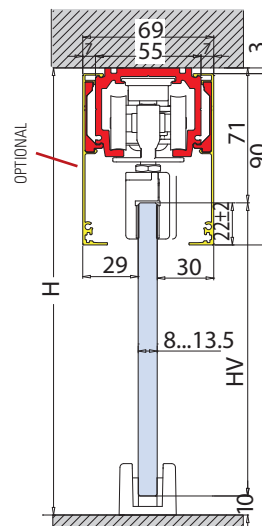

$$HV = H - 81$$

SIMPLE

V-1890 SET 1

€▶A.166

- Set per 1 anta scorrevole, fissaggio a parete/soffitto (solo 1 veletta inclusa)
- Sliding door set, wall/ceiling installation (only 1 cover included)
- Schiebetürset 1-flügelig, Wand-Deckenmontage (nur 1 Abdeckung enthalten)

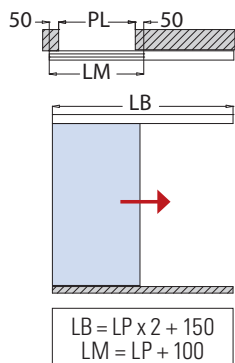

V-1890 SET 2

€▶A.167

- Set per 2 ante scorrevoli, fissaggio a parete/soffitto (solo 1 veletta inclusa)
- Sliding doors set, wall/ceiling installation (only 1 cover included)
- Schiebetürset 2-flügelig, Wand-Deckenmontage (nur 1 Abdeckung enthalten)

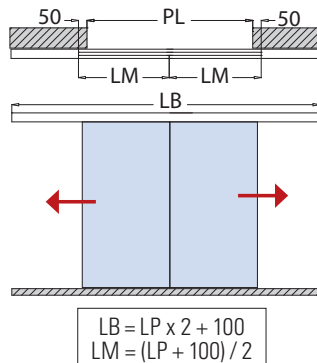

LAVORAZIONE VETRO GLASS PREPARATION GLASBEARBEITUNG

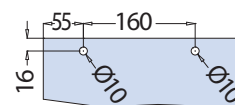

OPTIONAL (x 2)

- **ATTENZIONE:** Con fori di sicurezza **optional** l'anta minima con soft-close aumenta di 100 mm
- **WARNING:** With **optional** security holes min. panel's width soft-close must be increased of 100mm
- **ACHTUNG:** Wenn **optionale** Sicherheitsbohrungen und Soft-close eingesetzt werden, muss die Mindestbreite um 100mm verlängert werden

xme431a

COMPONENTI / COMPONENTS / EINZELTEILE ▶ 62

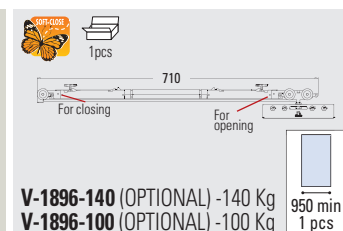
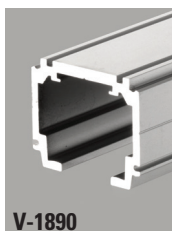

Cod.	Fin. / Fin. / Oberf.	V-1890 SET 1 FIX	V-1890 SET 1 MIS	V-1890 SET 2 FIX	V-1890 SET 2 MIS
V-1890 LB=2000 LB=3000 LB=4000 LB=6000	AN	1	—	1	—
V-1890-MIS LB= 1500→6000	AN	—	1	—	1
V-1632 LB=2000 LB=3000 LB=4000 LB=6000	AN/IXE	1	—	1	—
V-1632-MIS LB= 1500→6000	AN/IXE	—	1	—	1
V-1892	—	1	1	2	2
V-1896-140 Soft-close (OPTIONAL)	—	(1)	(1)	(2)	(2)
V-1896-100 Soft-close (OPTIONAL)	—	(1)	(1)	(2)	(2)
V-1824-140 Soft-close (OPTIONAL)	—	(1) (2)	(1) (2)	(2) (4)	(2) (4)
V-1824-100 Soft-close (OPTIONAL)	—	(1) (2)	(1) (2)	(2) (4)	(2) (4)
V-1898	AN	1	1	1	1
V-012	AN/IXE	1	1	2	2



BRIXIA 140 (OPTIONAL SOFT-CLOSE)

V-1893

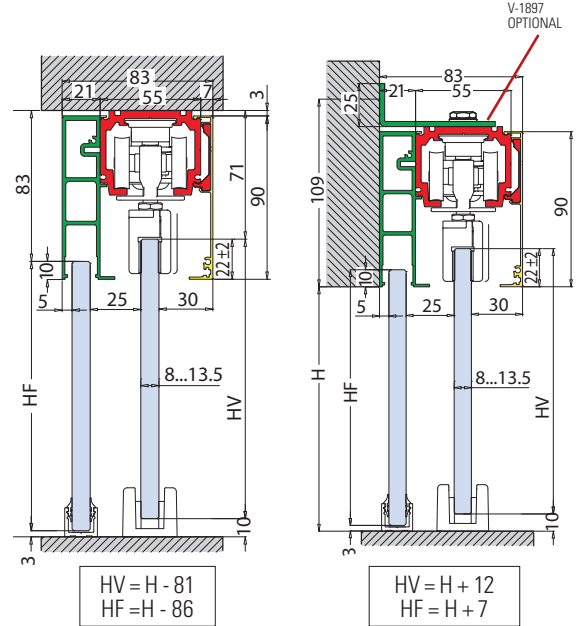
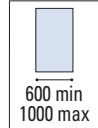
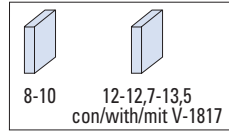

SIMPLE

V-1893 SET 1

€▶A.168

- Set per 1 anta scorrevole e vetro fisso, fissaggio a parete/soffitto
- Sliding door set with fixed panel, wall/ceiling installation
- Schiebetürset 1-flügelig mit Seitenteil, Wand-Deckenmontage

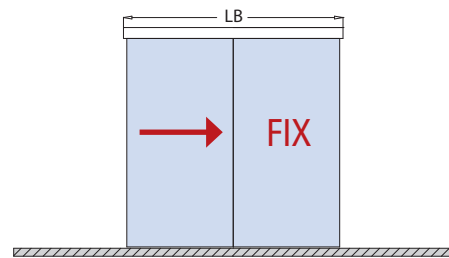

V-1893 SET 2

€▶A.169

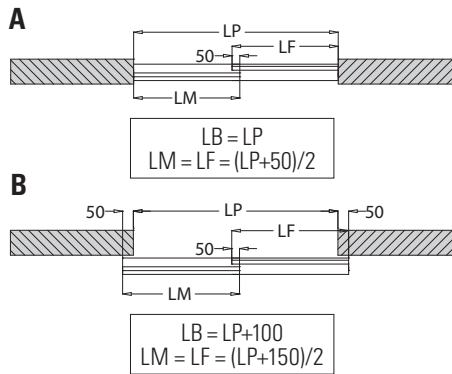

LAVORAZIONE VETRO GLASS PREPARATION GLASBEARBEITUNG

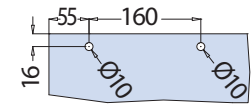

OPTIONAL (x 2)

- **ATTENZIONE:** Con fori di sicurezza **optional** l'anta minima con soft-close aumenta di 100mm
- **WARNING:** With **optional** security holes min. panel's width soft-close must be increased of 100mm
- **ACHTUNG:** Wenn **optionale** Sicherheitsbohrungen und Soft-close eingesetzt werden, muss die Mindestbreite um 100mm verlängert werden

xme431b

COMPONENTI / COMPONENTS / EINZELTEILE ▶ 62

V-1890	V-1894	V-1892	V-1899	V-012	V-1896-140 (OPTIONAL)-140 Kg	V-1896-100 (OPTIONAL)-100 Kg	V-1899	V-012
	V-1632	V-1824-140 (OPTIONAL) -140 Kg	V-1824-100 (OPTIONAL) -100 Kg	600 min 1 pcs	950 min 2 pcs	950 min 1 pcs		

OPTIONAL

VP-019-MT	VP-018-MT
2	3
1000 mm	
2000 mm	
3000 mm	

- Guarnizioni per sede vetro fisso
- Gaskets for fixed glass
- Dichtungen für Seitenteil

Cod.	Fin. / Fin. / Oberf.	V-1893 SET 1 FIX	V-1893 SET 1 MIS	V-1893 SET 2 FIX	V-1893 SET 2 MIS
V-1890 LB=2000 LB=3000 LB=4000 LB=6000	AN	1	—	1	—
V-1890-MIS LB= 1500→6000	AN	—	1	—	1
V-1632 LB=2000 LB=3000 LB=4000 LB=6000	AN/IXE	1	—	1	—
V-1632-MIS LB= 1500→6000	AN/IXE	—	1	—	1
V-1894 LB=2000 LB=3000 LB=4000 LB=6000	AN	1	—	1	—
V-1894-MIS LB= 1500→6000	AN	—	1	—	1
V-1892	—	1	1	2	2
V-1896-140 Soft-close (OPTIONAL)	—	(1)	(1)	(2)	(2)
V-1896-100 Soft-close (OPTIONAL)	—	(1)	(1)	(2)	(2)
V-1824-140 Soft-close (OPTIONAL)	—	(1) (2)	(1) (2)	(2) (4)	(2) (4)
V-1824-100 Soft-close (OPTIONAL)	—	(1) (2)	(1) (2)	(2) (4)	(2) (4)
V-1899	AN	1	1	1	1
V-012	AN/IXE	1	1	2	2
V-1897 Staffa / Bracket / Winkelverbinder (OPTIONAL)		1 x 400 mm	1 x 400 mm	1 x 400 mm	1 x 400 mm

V-1890 / V-1893 BRIXIA 140 (OPTIONAL SOFT-CLOSE)

COMPONENTI / COMPONENTS / EINZELTEILE

SIMPLE

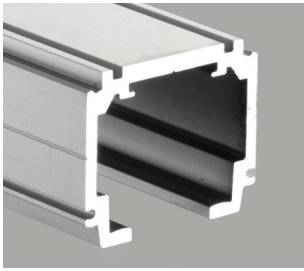

V-1890

- Binario Scorrevole BRIXIA 140
 - Track profile BRIXIA 140
 - Laufschienenprofil BRIXIA 140
- AN

€▶A.170

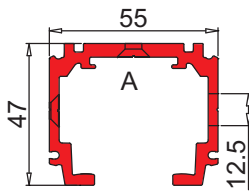
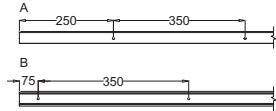

xme431c

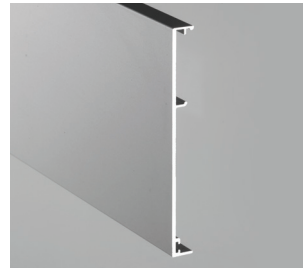

V-1632 H

- Veletta per binario V-1890
 - Cover profile for Track profile V-1890
 - Abdeckung für Laufschiene V-1890
- AN

€▶A.171



xme431c



V-1894

- Profilo per vetro fisso BRIXIA 140
 - Side panel profile BRIXIA 140
 - Seitenteilprofil BRIXIA 140
- AN

€▶A.172

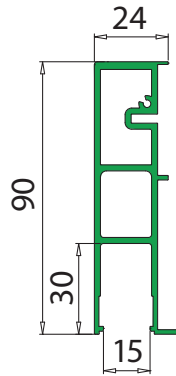

xme431c

OPTIONAL €▶A.187	
VP-019-MT	VP-018-MT
2	3
1000 mm - 2000 mm - 3000 mm	
<ul style="list-style-type: none"> • Guarnizioni per sede vetro fisso • Gaskets for fixed glass • Dichtungen für Seitenteil 	
8	10
12	

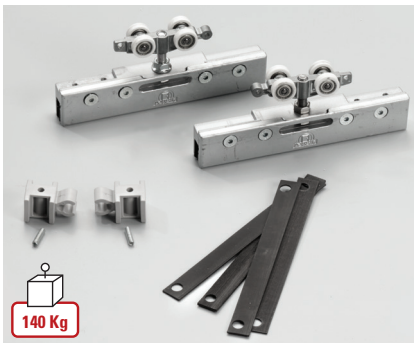

V-1892

- Set accessori per 1 anta scorrevole composto da 2 carrelli, morsetti per vetro 8-10 mm. 2 stoppers
- Accessories set for 1 sliding panel consisting of N°2 trolley hangers with clamp carriage for 8/10 mm glass. N°2 endstops
- Zubehör für 1 Schiebetür bestehend aus: N°2 Klemm - Laufwagen für 8/10 mm Glas. N°2 Stopper

€▶A.173

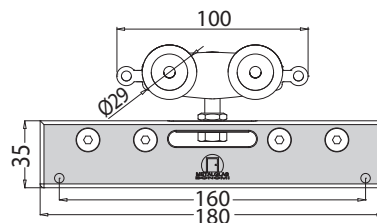
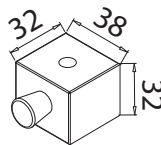
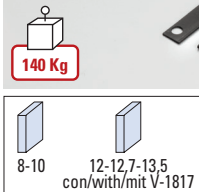

xme431c



V-090

- Pinza
- Clamp
- Klemmschuh

€▶A.178

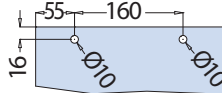

- Fori optional
- Holes optional
- Bohrungen Optional

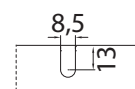
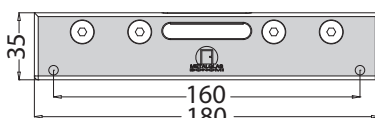

xme431c / xme425a

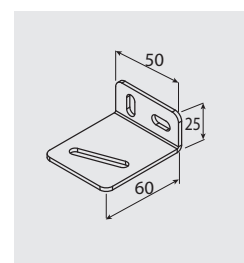

V-1867

- Staffa per fissaggio a parete per sistema V-1863 (circa 1 pezzo ogni 400 mm)
- Angled profile for wall installation for system V-1863 (about 1 piece every 400 mm)
- Winkelverbinder für Wandmontage System V-1863 (1 Stück je ca 400 mm)

€▶A.135

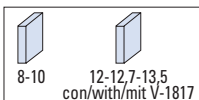

V-1896-140 Kg
V-1896-100 Kg

- 1 pcs soft-close double

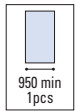
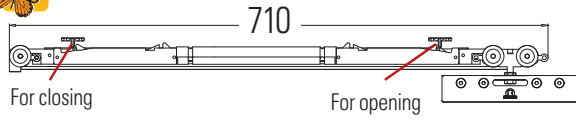

xme431c

€▶A.177 €▶A.176



V-1824-140 Kg
V-1824-100 Kg

- 1 pcs Soft-close

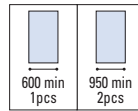
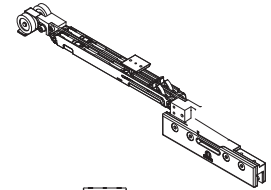

xme431c

€▶A.175

€▶A.174

SIMPLE

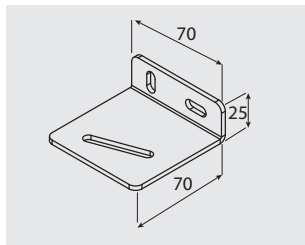

V-1897

- Staffa per fissaggio a parete binario V-1890 e profilo per fisso V-1894 (circa 1 pezzo ogni 400 mm)
- Winkelverbinder für Wandmontage Laufschiene V-1890 und Seitenteilprofil V-1894 (1 Stück je ca 400 mm)
- Angled profile for wall installation track profile V-1890 and side panel profile V-1894 (about 1 piece every 400 mm)

€▶A.186

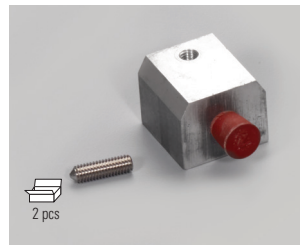

V-1891

- Stoppers Brixia 140 Kg

€▶A.181

xme425c

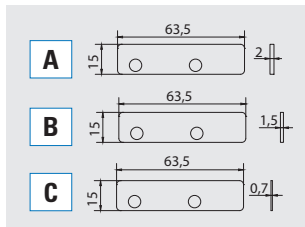

V-1817-A
V-1817-B
V-1817-C

- Kit spessori per vetro 12 - 12,7 - 13,5 per 2 pinze V-090 e V-090-T
- Kit spacers for glass thickness 12 - 12,7 - 13,5 for 2 clamps V-090 and V-090-T
- Kit Distanzscheiben für Glasdicke 12 - 12,7 - 13,5 für 2 Klemm-Lauwagen V-090 und V-090-T

€▶A.179



V-1895

- Carrello Brixia 140 Kg
- Carrier Brixia 140 Kg
- Laufwagen Brixia 140 Kg

€▶A.180

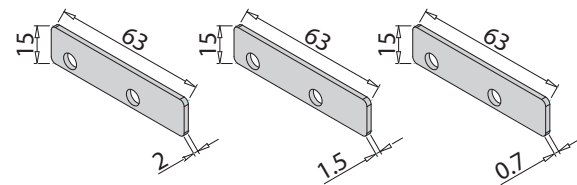

xme425t

xme425i

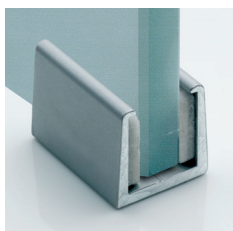

V-012

- Guida a pavimento per scorrevole con feltrini per vetro 8 e 10 mm
 - Floor guide with felt strips for glass sliding door a 8 and 10mm
 - Bodenführung mit Filzgleiter für Glas 8 und 10 mm
- AN - NS - CR

€▶A.182

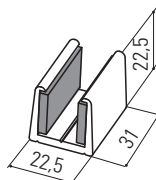

v-012

V-1898

- Paio tappi finali per sistema V-1890
- Pair endcaps for system V-1890
- Paar Endkappe für System V-1890

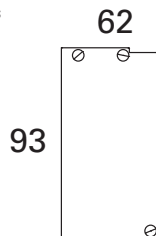

€▶A.184

V-1899

- Paio tappi finali per sistema V-1893
- Pair endcaps for system V-1893
- Paar Endkappe für System V-1893

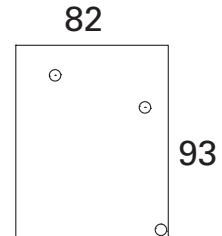

€▶A.185