

## BRIXIA TELESCOPICO 3 VIE + FISSO (OPTIONAL SOFT-CLOSE)



**V-1835**  
TRASCINAMENTO SINCRO CON FUNE  
SINCRO DRAGGING SYSTEM WITH CABLE  
SINCRO MITNEHMER KIT MIT SEILZUG



**V-1885**  
TRASCINAMENTO MECCANICO  
MECHANICAL DRAGGING SYSTEM  
MIT MECHANISCHEM MITNEHMER

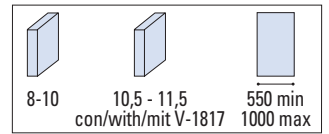

TELESCOPIC

**COMPONENTI / COMPONENTS / EINZELTEILE ▶ 126**

**V-1834**

V-1830 + V-1834 + V-1821/-P

**V-1833**

**V-1824-70 (OPTIONAL) - 70 Kg**

SOFT-CLOSE

1pcs

700 min

OPTIONAL	
VP-019-MT	VP-018-MT
2	3
1000 mm	
2000 mm	
3000 mm	

- Guarnizioni per sede vetro fisso
- Gaskets for fixed glass
- Dichtungen für Seitenteil

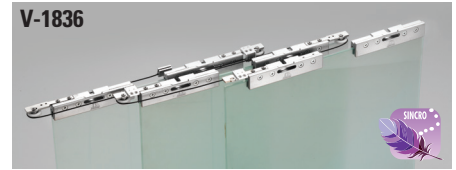
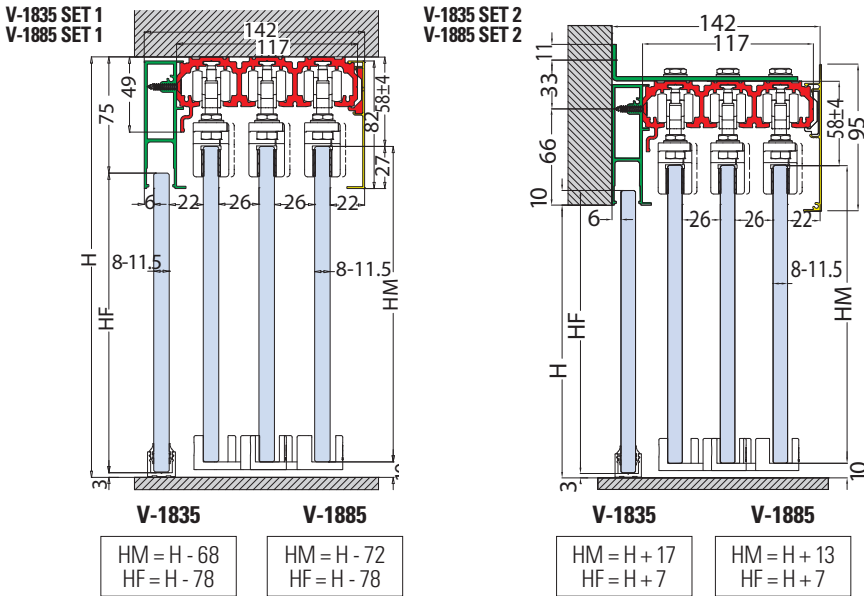

**V-1835**  
TRASCINAMENTO SINCRONICO CON FUNE  
SINCRONIC DRAGGING SYSTEM WITH CABLE  
SINCRONIC MITNEHMER KIT MIT SEILZUG



**V-1885**  
TRASCINAMENTO MECCANICO  
MECHANICAL DRAGGING SYSTEM  
MIT MECHANISHEM MITNEHMER

- Sistema per 2 ante scorrevoli telescopiche con kit di trascinamento
- Telescopic sliding door system 2-ways with dragging mechanism
- Teleskopisches Schiebetürsystem 2-läufig mit Mitnehmer Kit

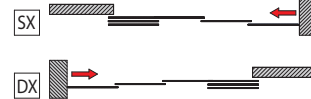
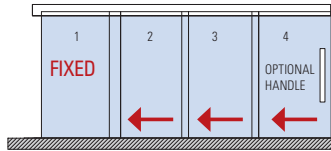

- Sinistra
- Left
- Links
- Destra
- Right
- Rechts

**V-1835 SET 1** • Soffitto • Ceiling • Decke ▶ A.437

**V-1885 SET 1** • Soffitto • Ceiling • Decke ▶ A.439

**V-1835 SET 2** • Parete • Wall • Wand ▶ A.438

**V-1885 SET 2** • Parete • Wall • Wand ▶ A.440

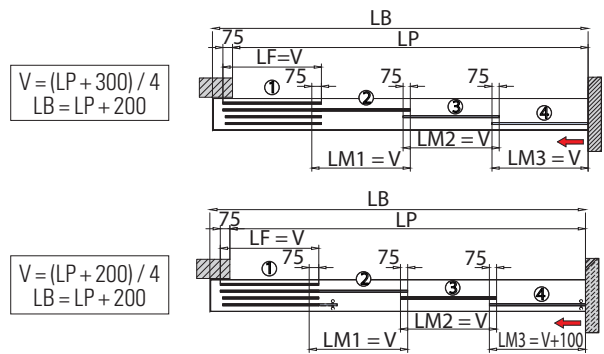
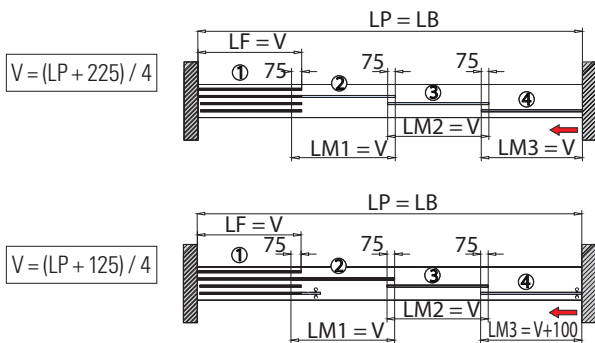

xme425rs

Cod.	Fin. / Fin. / Oberf.	V-1835 / V-1885 SET 1 FIX	V-1835 / V-1885 SET 1 MIS	V-1835 / V-1885 SET 2 FIX	V-1835 / V-1885 SET 2 MIS
<b>V-1830</b> LB=2000 LB=3000 LB=4000 LB=6000	AN	1	-	1	-
<b>V-1830-MIS</b> LB= 1500→6000	AN	-	1	-	1
<b>V-1834</b> LB=2000 LB=3000 LB=4000 LB=6000	AN	1	-	1	-
<b>V-1834-MIS</b> LB= 1500→6000	AN	-	1	-	1
<b>V-1821 / V-1821-P</b> LB=2000 LB=3000 LB=4000 LB=6000	AN	1	-	1	-
<b>V-1821-MIS / V-1821-MIS</b> LB= 1500→6000	AN	-	1	-	1
<b>V-1833</b>	-	1	1	1	1
<b>V-1836</b> (per set V-1835) <b>V-1886</b> (per set V-1885)	-	1	1	1	1
<b>V-1835</b> Staffa / Bracket / Winkelverbinder	-	-	-	1 x 400 mm	1 x 400 mm
<b>V-1824-70</b> Soft-close (OPTIONAL)	-	(1)	(1)	(1)	(1)
<b>V-1839</b> Tappi / Endcaps / Endkappe (OPTIONAL)	AN	(1)	(1)	(1)	(1)

TELESCOPIC



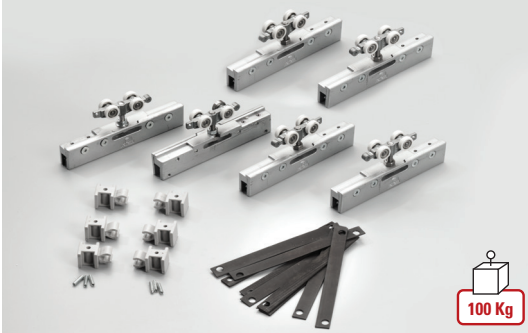

**V-1833**

- Set di accessori per 3 ante scorrevoli composto da: N°6 carrelli pinze, N°6 fermacarrello
- Sliding accessory set for 3 panels complete with: N°6 roller carriers - N°6 endstops
- Zubehör komplett mit: N°6 Klemm-Laufwagen, N°6 Endanschläge

€▶A.447

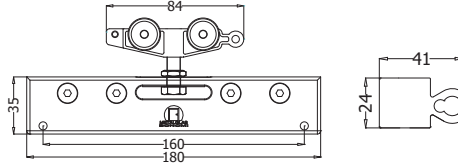

100 Kg

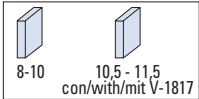

xme425t



**V-1826 DX-SX**

- Kit morsetti trascinamento Sincro con fune 2 ante scorrevoli compreso di guide a pavimento V-012 e V-099-C
- Dragging kit Sincro with cable for 2 sliding panels, including floor guides V-012 and V-099-C
- Mitnehmer kit Sincro mit Seilzug für 2 bewegliche Schiebetüren mit Bodenführungen V-012 und V-099-C

€▶A.448

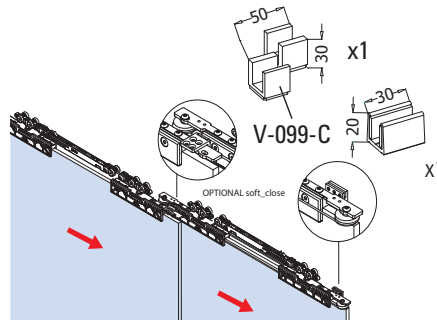
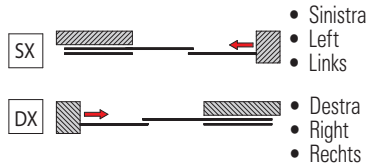

xme425lm



**V-1836 DX-SX**

- Kit morsetti trascinamento Sincro con fune 3 ante scorrevoli compreso di guide a pavimento V-012 e V-099-C
- Dragging kit Sincro with cable for 3 sliding panels, including floor guides V-012 and V-099-C
- Mitnehmer kit Sincro mit Seilzug für 3 bewegliche Schiebetüren mit Bodenführungen V-012 und V-099-C

€▶A.450

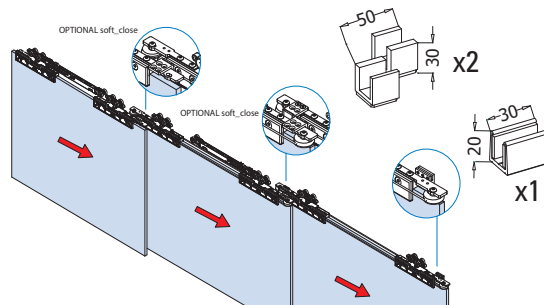
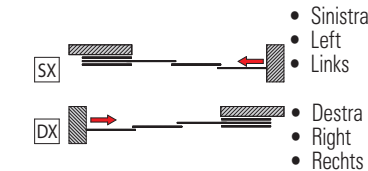

xme425pq



**V-1876 DX-SX**

- Kit morsetti trascinamento meccanico per 2 ante scorrevoli compreso di guide a pavimento V-012 e V-099-C
- Dragging kit for 2 sliding panels, including floor guides V-012 and V-099-C
- Mitnehmer kit für 2 bewegliche Schiebetüren mit Bodenführungen V-012 und V-099-C

€▶A.449

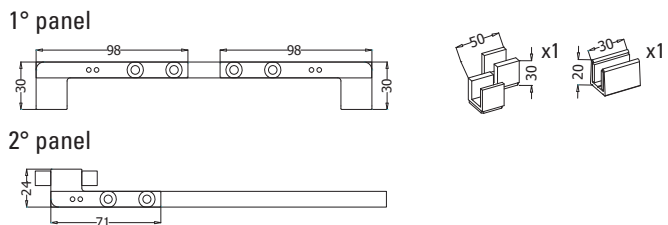
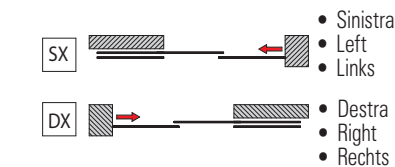

xme425t

TELESCOPIC

# V-1820 / V-1870 / V-1825 / V-1875 / V-1830 / V-1880 / V-1835 / V-1885 BRIXIA TELESCOPICO

## COMPONENTI / COMPONENTS / EINZELTEILE



### V-1886 DX-SX

- Kit morsetti trascinamento meccanico per 3 ante scorrevoli compreso di guide a pavimento V-012 e V-099-C
- Dragging kit for 3 sliding panels, including floor guides V-012 and V-099-C
- Mitnehmer kit für 3 bewegliche Schiebetüren mit Bodenführungen V-012 und V-099-C

€▶A.451

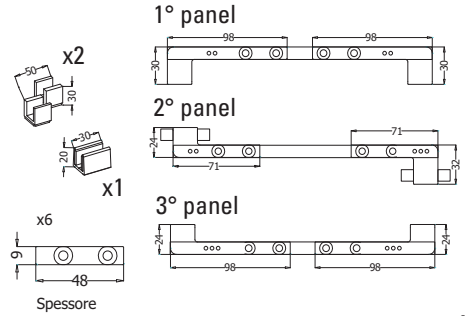
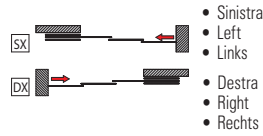

xme425t

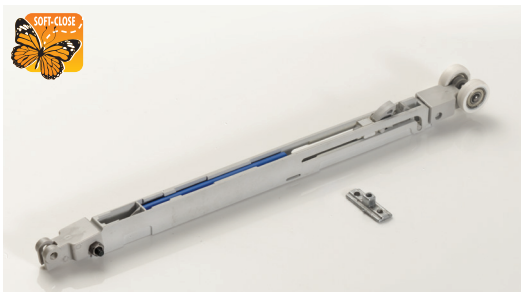

### V-1824-70 Kg

- Optional stopper Soft-close (in chiusura) per scorrevole Telescopico V-1820, V-1830
- Optional stopper with Soft-close mechanism (only closing) for sliding system Telescopico V-1820, V-1830
- Optional stopper mit Soft-close (nur in Schliessrichtung) für Telescopisch V-1820, V-1830

€▶A.452

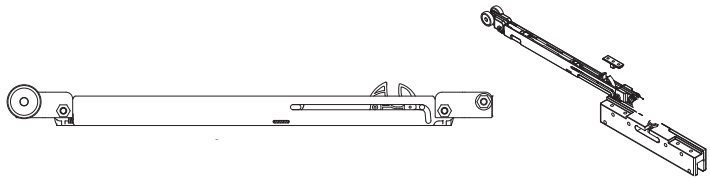

xme425t

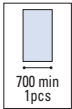

### V-1828-S

- Paio tappi finali per sistema V-1820/ V-1870
- Pair endcaps for system V-1820/ V-1870
- Paar Endkappen für System V-1820/ V-1870

AN-IXE

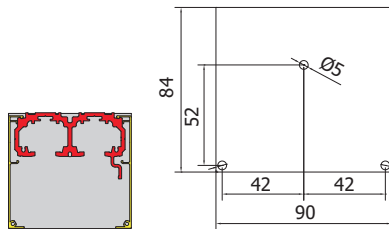

281p028

€▶A.461

### V-1828-P

- Paio tappi finali per sistema V-1820/ V-1870
- Pair endcaps for system V-1820/ V-1870
- Paar Endkappen für System V-1820/ V-1870

AN-IXE

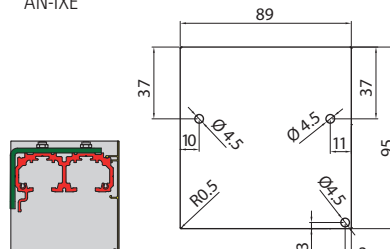

281p042

€▶A.460

### V-1828-F

- Paio tappi finali per sistema V-1825/ V-1875
- Pair endcaps for system V-1825/ V-1875
- Paar Endkappen für System V-1825/ V-1875

AN-IXE

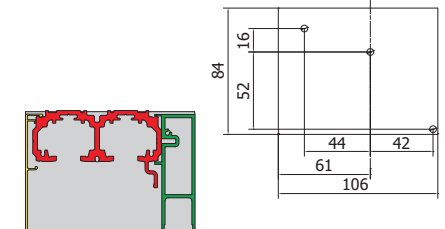

281p030

€▶A.462

### V-1838-S

- Paio tappi finali per sistema V-1830/ V-1880
- Pair endcaps for system V-1830/ V-1880
- Paar Endkappen für System V-1830/ V-1880

AN-IXE

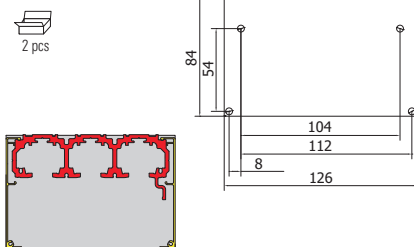

281P031

€▶A.463

### V-1838-P

- Paio tappi finali per sistema V-1830/ V-1880
- Pair endcaps for system V-1830/ V-1880
- Paar Endkappen für System V-1830/ V-1880

AN-IXE

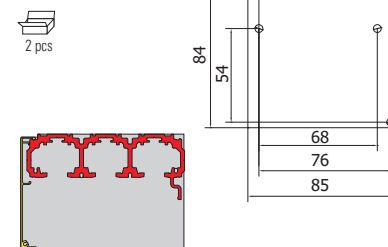

281P032

€▶A.464

### V-1839

- Paio tappi finali per sistema V-1835/ V-1885
- Pair endcaps for system V-1835/ V-1885
- Paar Endkappen für System V-1835/ V-1885

AN-IXE

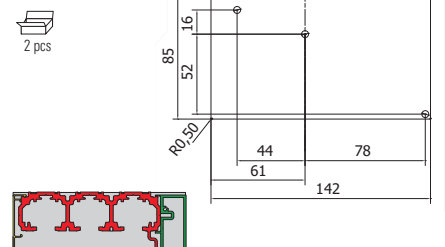

281P033

€▶A.465



**V-099-C DX / V-099-C SX**

- Doppia guida a pavimento destra o sinistra
- Double floor guide right or left
- Doppel Bodenführung rechts oder links

€▶A.469

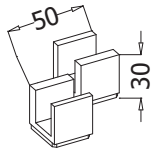
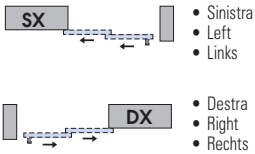

**V-090-T**

- Pinza
- Clamp
- Klemmschuh

€▶A.466

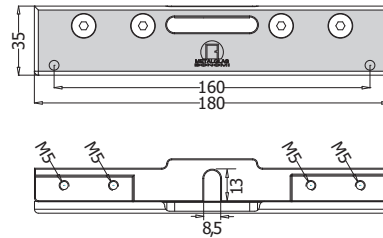
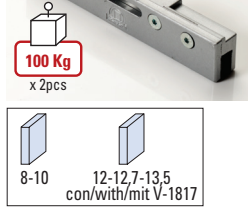

xme425t

**V-1817-A / V-1817-B / V-1817-C**

- Kit spessori vetro OPTIONAL 12 - 12,7 - 13,5
- Kit spacers for glass thickness OPTIONAL 12 - 12,7 - 13,5
- Kit Distanzscheiben für Glasdicke OPTIONAL 12 - 12,7 - 13,5

€▶A.467

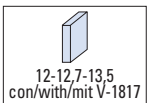
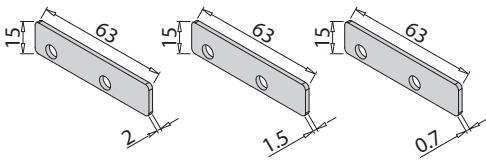

xme425t



**V-1816**

- Carrello Brixia Heavy
- Carrier Brixia Heavy
- Laufwagen Brixia Heavy

€▶A.470

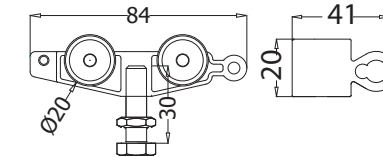

- V-1817**
- Stoppers Brixia

€▶A.136

xme425t

**V-1822**

€▶A.456

- 1 pezzo staffa per fissaggio a parete, (circa 1 pz ogni 400mm)
- 1 pcs bracket for wall installation (about 1 pcs each 400 mm)
- 1 Stück Winkelverbinder für Wandmontage (1 Stück je ca. 400 mm)

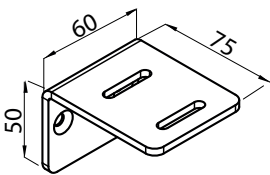

281P040

**V-1825**

€▶A.458

- 1 pezzo staffa per fissaggio a parete, (circa 1 pz ogni 400 mm)
- 1 pcs bracket for wall installation (about 1 pcs each 400 mm)
- 1 Stück Winkelverbinder für Wandmontage (1 Stück je ca. 400 mm)

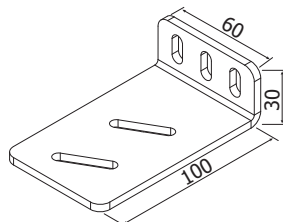

281P021

**V-1837**

€▶A.457

- 1 pezzo staffa per fissaggio a parete, (circa 1 pz ogni 400 mm)
- 1 pcs bracket for wall installation (about 1 pcs each 400 mm)
- 1 Stück Winkelverbinder für Wandmontage (1 Stück je ca. 400 mm)

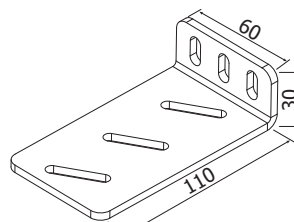

281P019

**V-1835**

€▶A.459

- 1 pezzo staffa per fissaggio a parete, (circa 1 pz ogni 400 mm)
- 1 pcs bracket for wall installation (about 1 pcs each 400 mm)
- 1 Stück Winkelverbinder für Wandmontage (1 Stück je ca. 400 mm)

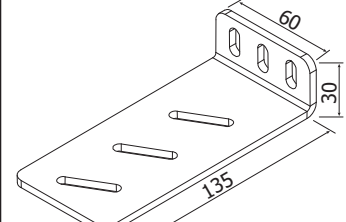

281P022

**V-2014-MIX**

€▶A.471

- Canalina per vetro fisso escluso guarnizioni
- U channel for fixed panel, gaskets not included
- U Profil für Seitenteil Dichtungen nicht inkl.

AN - IXE

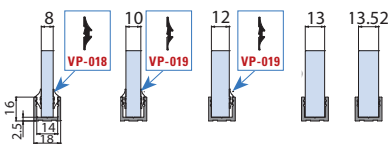

Cod.	Fin./Fin./Oberf.
V-2014-2000 mm	AN / IXE / NO
V-2014-3000 mm	AN / IXE / NO
V-2014-6000 mm	AN / IXE / NO

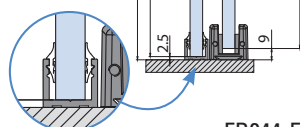

FB044-E

**LAV-TEL-BRIXIA**

€▶A.454

- Lavorazione optional per manutenzione Soft-close su binario telescopico
- Optional recess for maintenance of Soft-close device in the telescopic rails
- Optionale Ausfräsung für die Wartung von Soft-close stopper in den Teleskopischen Laufschienen

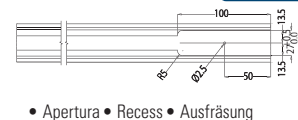

- Apertura • Recess • Ausfräsung

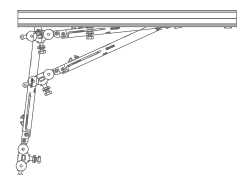

TELESCOPIC