

## BRIXIA TELESCOPICO 3 VIE (OPTIONAL SOFT-CLOSE)



**V-1830**  
TRASCINAMENTO SINCRONICO CON FUNE  
SINCRO DRAGGING SYSTEM WITH CABLE  
SINCRO MITNEHMER KIT MIT SEILZUG



**V-1880**  
TRASCINAMENTO MECCANICO  
MECHANICAL DRAGGING SYSTEM  
MIT MECHANISCHEM MITNEHMER

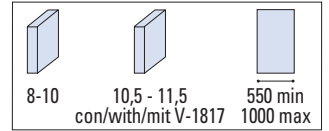

TELESCOPICO

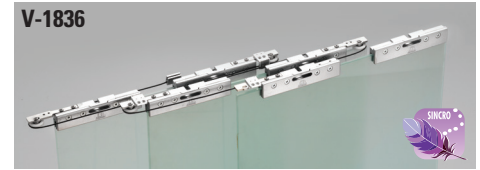
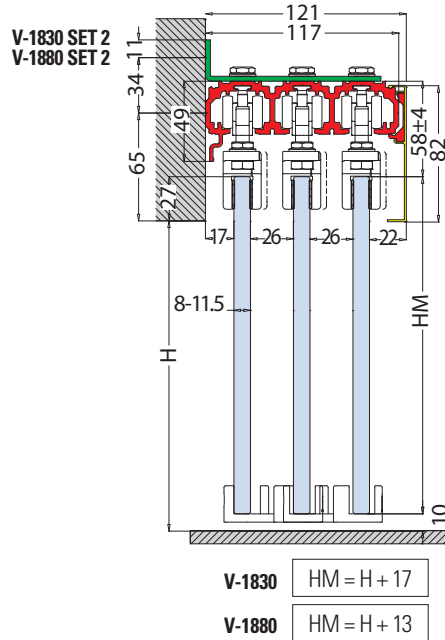
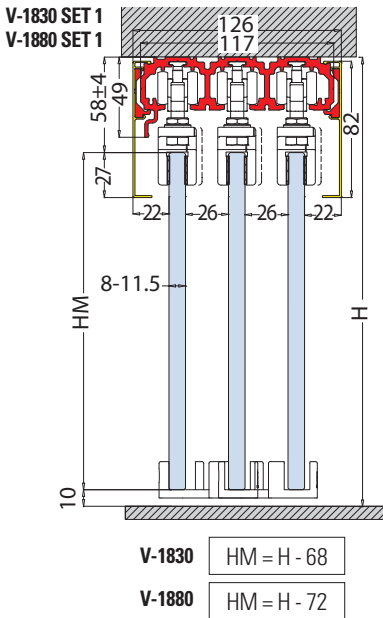
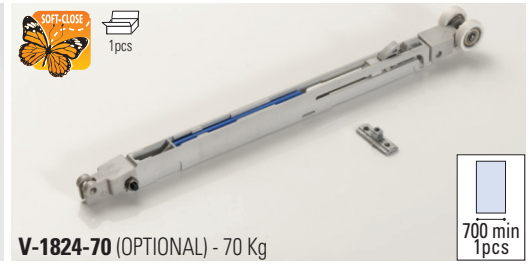
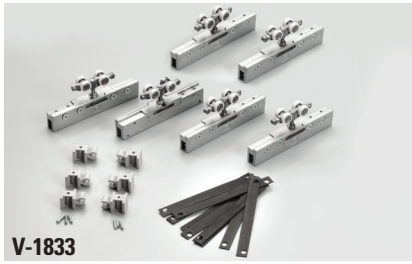
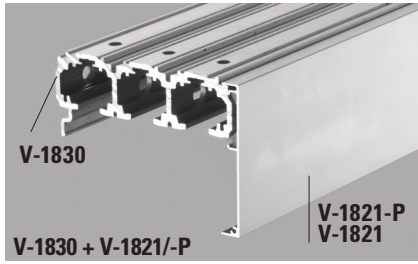
**COMPONENTI / COMPONENTS / EINZELTEILE ▶ 126**

**V-1830**  
TRASCINAMENTO SINCRONICO CON FUNE  
SINCRONIC DRAGGING SYSTEM WITH CABLE  
SINCRONIC MITNEHMER KIT MIT SEILZUG



**V-1880**  
TRASCINAMENTO MECCANICO  
MECHANICAL DRAGGING SYSTEM  
MIT MECHANISCHEM MITNEHMER

**V-1830 / V-1880 SET 1** • Soffitto • Ceiling • Decke  
**V-1830 / V-1880 SET 2** • Parete • Wall • Wand

- Sistema per 3 ante scorrevoli telescopiche con kit di trascinamento
- Telescopic sliding door system 3-ways with dragging mechanism
- Teleskopisches Schiebetürsystem 3-läufig mit Mitnehmer Kit

€▶ A.433 €▶ A.435  
€▶ A.434 €▶ A.436

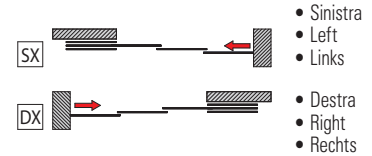
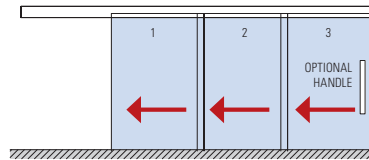

TELESCOPIC

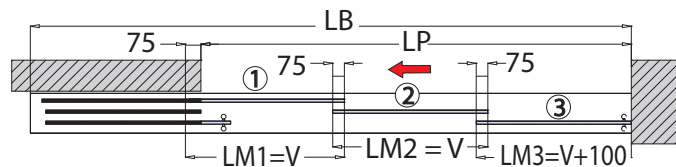
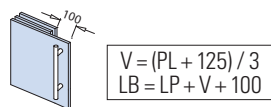
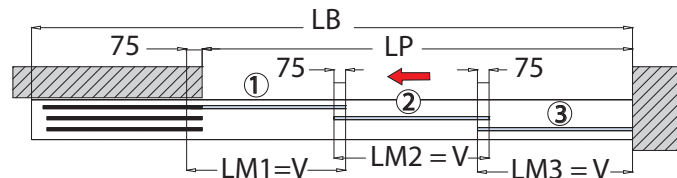
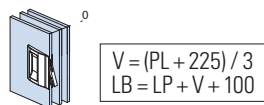

xme425pq

Cod.	Fin. / Fin. / Oberf.	V-1830 / V-1880 SET 1 FIX	V-1830 / V-1880 SET 1 MIS	V-1830 / V-1880 SET 2 FIX	V-1830 / V-1880 SET 2 MIS
<b>V-1830</b> LB=2000 LB=3000 LB=4000 LB=6000	AN	1	-	1	-
<b>V-1830-MIS</b> LB= 1500→6000	AN	-	1	-	1
<b>V-1821 / V-1821-P</b> LB=2000 LB=3000 LB=4000 LB=6000	AN	1	-	1	-
<b>V-1821-MIS / V-1821-MIS</b> LB= 1500→6000	AN	-	1	-	1
<b>V-1833</b>	-	1	1	1	1
<b>V-1836</b> (per set V-1830) <b>V-1886</b> (per set V-1880)	-	1	1	1	1
<b>V-1837</b> Staffa / Bracket / Winkerverbinder (OPTIONAL)	-	-	-	1 x 400 mm	1 x 400 mm
<b>V-1824-70</b> Soft-close (OPTIONAL)	-	(1)	(1)	(1)	(1)
<b>V-1838-S</b> Tappi per soffitto / Endcap for ceiling / Endkappe für Decke (OPTIONAL)	AN	(1)	(1)	-	-
<b>V-1838-P</b> Tappi per parete / Endcap for wall / Endkappe für Wand (OPTIONAL)	AN	-	-	(1)	(1)

# V-1820 / V-1870 / V-1825 / V-1875 / V-1830 / V-1880 / V-1835 / V-1885 BRIXIA TELESCOPICO

## COMPONENTI / COMPONENTS / EINZELTEILE

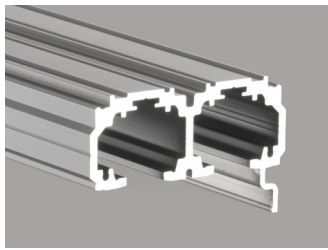

### V-1820

- Binario Telescopico Brixia a 2 vie
- Track profile Telescopic Brixia 2 ways
- Laufschienenprofil Telescopisch Brixia 2-läufig

AN

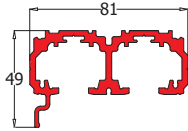
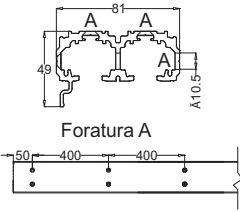

€▶A.441

xme425t

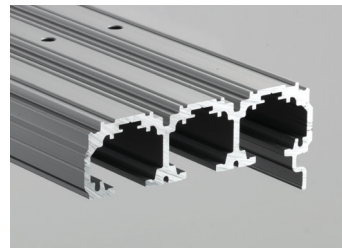

### V-1830

- Binario Telescopico Brixia a 3 vie
- Track profile Telescopic Brixia 3 ways
- Laufschienenprofil Telescopisch Brixia 3-läufig

AN

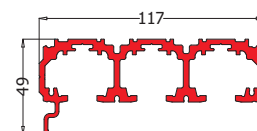
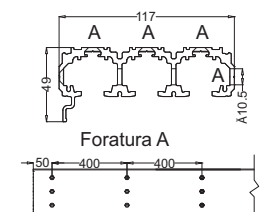

€▶A.442

xme425t



### V-1821

- Veletta per binari Telescopici Brixia in alluminio anodizzato
- Cover profile anodised aluminium for Telescopic track profile Brixia
- Verkleidungsprofil aluminium für Laufschienenprofile Brixia

AN-IXE

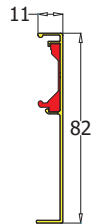

€▶A.443

xme425t



### V-1821-P

- Veletta per binari telescopici BRIXIA set 2 a parete in alluminio anodizzato.
- Cover profile anodised aluminium for telescopic track profiles BRIXIA set 2 wall installation
- Verkleidungsprofil aluminium für Laufschienenprofile BRIXIA set 2 Wandmontage

AN-IXE



€▶A.444

xme425t



### V-1834

- Profilo per vetro fisso per binario V-1820 / V-1830
- Side panel profile for track profile V-1820 / V-1830
- Seitenteilprofil für Laufschiene V-1820 / V-1830

AN

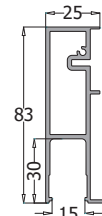

€▶A.445

xme425t

OPTIONAL	
VP-019-MT	VP-018-MT
1000 mm - 2000 mm - 3000 mm	
<ul style="list-style-type: none"> <li>• Guarnizioni per sede vetro fisso</li> <li>• Gaskets for fixed glass</li> <li>• Dichtungen für Seitenteil</li> </ul>	

€▶A.455

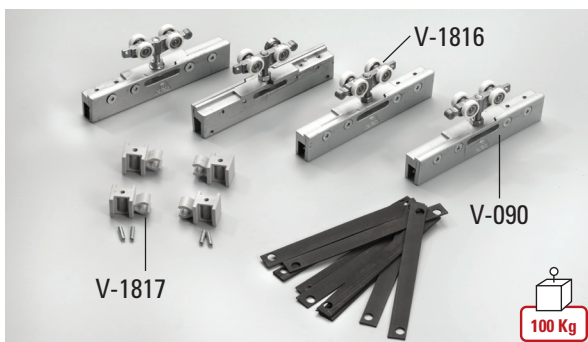

### V-1823

- Set di accessori per 2 ante scorrevoli composto da: N°4 carrelli pinze, N°4 fermacarrello
- Sliding accessory set for 2 panels complete with: N°4 roller carriers - N°4 endstops
- Zubehör komplett mit: N°4 Klemm-Laufwagen, N°4 Endanschläge

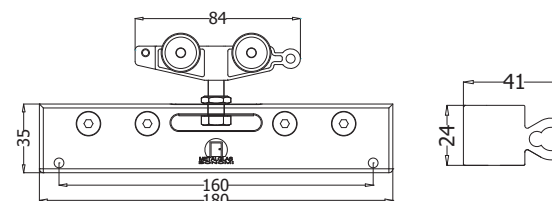

€▶A.446

xme425t



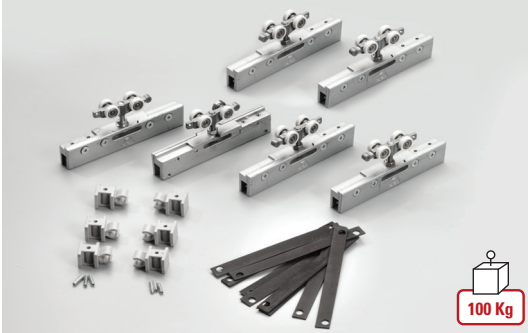

**V-1833**

- Set di accessori per 3 ante scorrevoli composto da: N°6 carrelli pinze, N°6 fermacarrello
- Sliding accessory set for 3 panels complete with: N°6 roller carriers - N°6 endstops
- Zubehör komplett mit: N°6 Klemm-Laufwagen, N°6 Endanschläge

€▶A.447

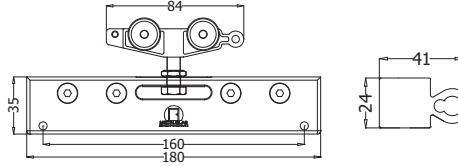

100 Kg

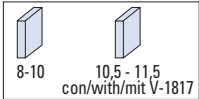

xme425t



**V-1826 DX-SX**

- Kit morsetti trascinamento Sincro con fune 2 ante scorrevoli compreso di guide a pavimento V-012 e V-099-C
- Dragging kit Sincro with cable for 2 sliding panels, including floor guides V-012 and V-099-C
- Mitnehmer kit Sincro mit Seilzug für 2 bewegliche Schiebetüren mit Bodenführungen V-012 und V-099-C

€▶A.448

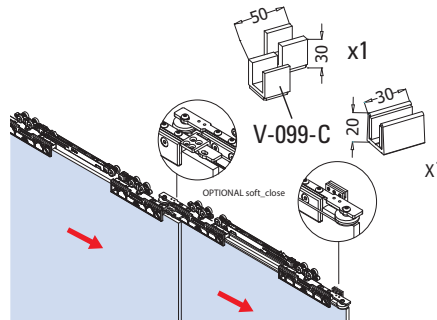
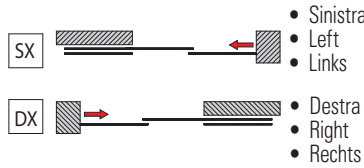

xme425lm

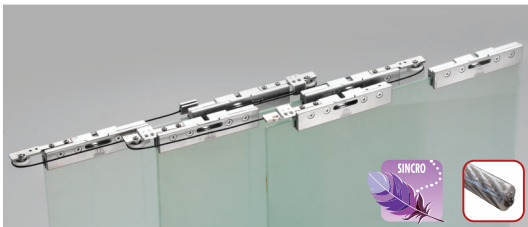

**V-1836 DX-SX**

- Kit morsetti trascinamento Sincro con fune 3 ante scorrevoli compreso di guide a pavimento V-012 e V-099-C
- Dragging kit Sincro with cable for 3 sliding panels, including floor guides V-012 and V-099-C
- Mitnehmer kit Sincro mit Seilzug für 3 bewegliche Schiebetüren mit Bodenführungen V-012 und V-099-C

€▶A.450

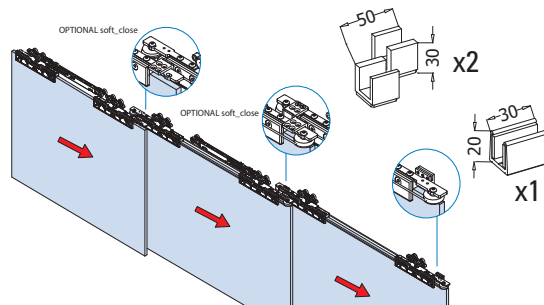
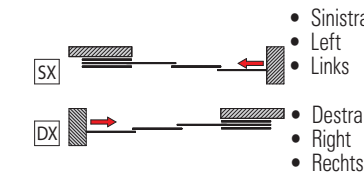

xme425pq



**V-1876 DX-SX**

- Kit morsetti trascinamento meccanico per 2 ante scorrevoli compreso di guide a pavimento V-012 e V-099-C
- Dragging kit for 2 sliding panels, including floor guides V-012 and V-099-C
- Mitnehmer kit für 2 bewegliche Schiebetüren mit Bodenführungen V-012 und V-099-C

€▶A.449

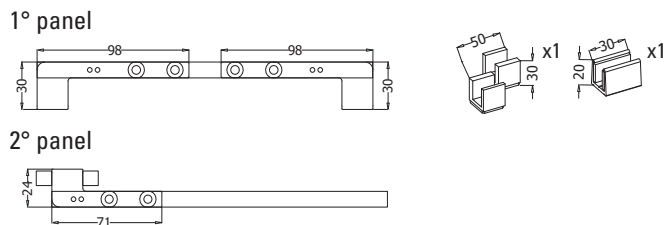
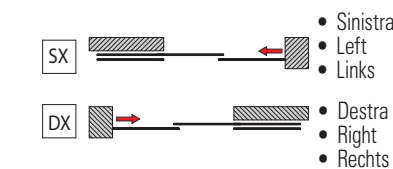

xme425t

TELESCOPIC

# V-1820 / V-1870 / V-1825 / V-1875 / V-1830 / V-1880 / V-1835 / V-1885 BRIXIA TELESCOPICO

## COMPONENTI / COMPONENTS / EINZELTEILE



### V-1886 DX-SX

- Kit morsetti trascinamento meccanico per 3 ante scorrevoli compreso di guide a pavimento V-012 e V-099-C
- Dragging kit for 3 sliding panels, including floor guides V-012 and V-099-C
- Mitnehmer kit für 3 bewegliche Schiebetüren mit Bodenführungen V-012 und V-099-C

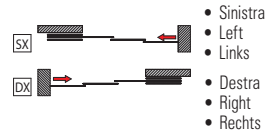

- Sinistra
- Left
- Links
- Destra
- Right
- Rechts

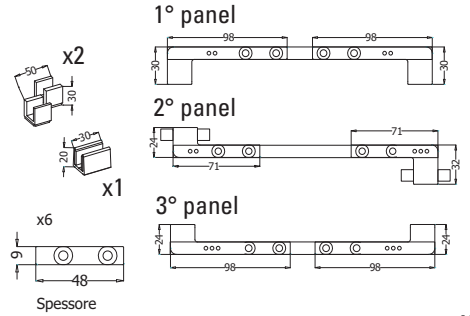

€▶A.451

xme425t

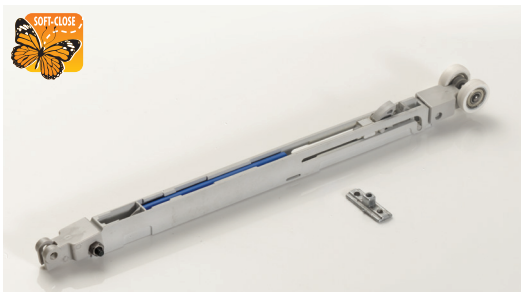

### V-1824-70 Kg

- Optional stopper Soft-close (in chiusura) per scorrevole Telescopico V-1820, V-1830
- Optional stopper with Soft-close mechanism (only closing) for sliding system Telescopico V-1820, V-1830
- Optional stopper mit Soft-close (nur in Schliessrichtung) für Telescopisch V-1820, V-1830

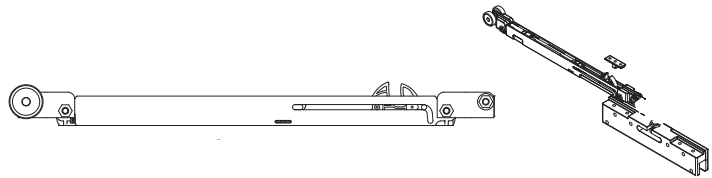

€▶A.452

xme425t

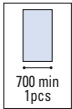

### V-1828-S

- Paio tappi finali per sistema V-1820/ V-1870
- Pair endcaps for system V-1820/ V-1870
- Paar Endkappen für System V-1820/ V-1870

AN-IXE

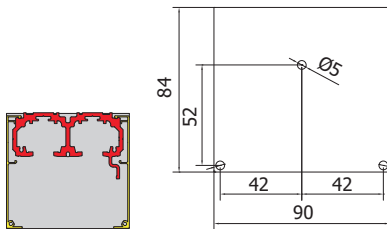

2 pcs

281p028

€▶A.461

### V-1828-P

- Paio tappi finali per sistema V-1820/ V-1870
- Pair endcaps for system V-1820/ V-1870
- Paar Endkappen für System V-1820/ V-1870

AN-IXE

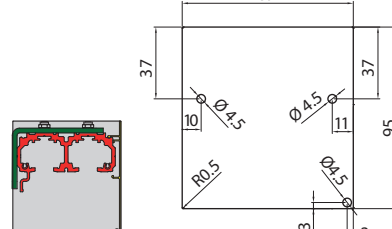

2 pcs

281p042

€▶A.460

### V-1828-F

- Paio tappi finali per sistema V-1825/ V-1875
- Pair endcaps for system V-1825/ V-1875
- Paar Endkappen für System V-1825/ V-1875

AN-IXE

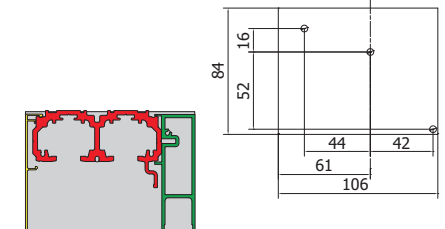

2 pcs

281p030

€▶A.462

### V-1838-S

- Paio tappi finali per sistema V-1830/ V-1880
- Pair endcaps for system V-1830/ V-1880
- Paar Endkappen für System V-1830/ V-1880

AN-IXE

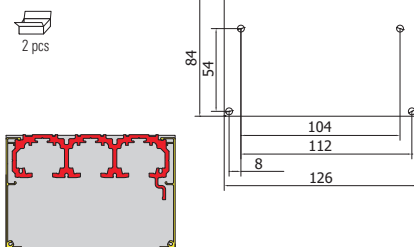

2 pcs

281P031

€▶A.463

### V-1838-P

- Paio tappi finali per sistema V-1830/ V-1880
- Pair endcaps for system V-1830/ V-1880
- Paar Endkappen für System V-1830/ V-1880

AN-IXE

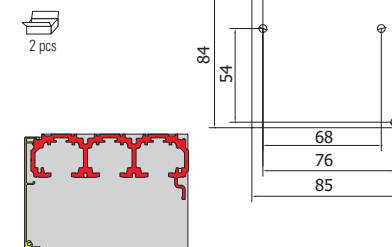

2 pcs

281P032

€▶A.464

### V-1839

- Paio tappi finali per sistema V-1835/ V-1885
- Pair endcaps for system V-1835/ V-1885
- Paar Endkappen für System V-1835/ V-1885

AN-IXE

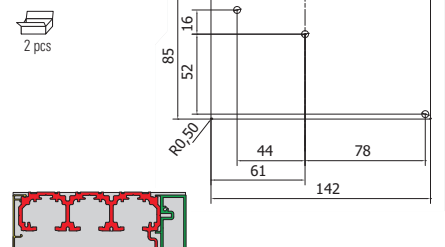

2 pcs

281P033

€▶A.465

TELESCOPIC



**V-099-C DX / V-099-C SX**

- Doppia guida a pavimento destra o sinistra
- Double floor guide right or left
- Doppel Bodenführung rechts oder links

€▶A.469

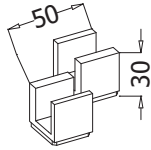
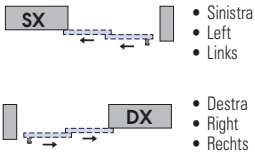

xme425t



**V-090-T**

- Pinza
- Clamp
- Klemmschuh

€▶A.466

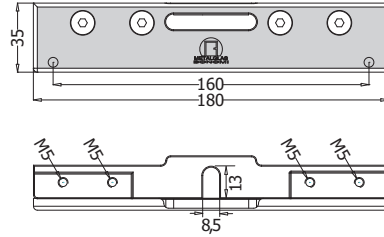
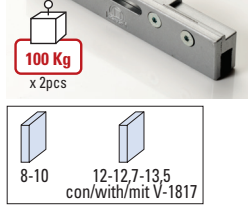

**V-1817-A / V-1817-B / V-1817-C**

- Kit spessori vetro OPTIONAL 12 - 12,7 - 13,5
- Kit spacers for glass thickness OPTIONAL 12 - 12,7 - 13,5
- Kit Distanzscheiben für Glasdicke OPTIONAL 12 - 12,7 - 13,5

€▶A.467

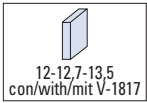
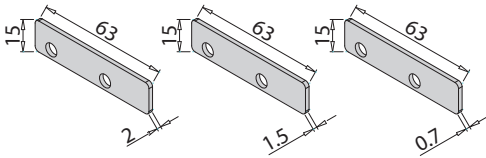

xme425t



**V-1816**

- Carrello Brixia Heavy
- Carrier Brixia Heavy
- Laufwagen Brixia Heavy

€▶A.470

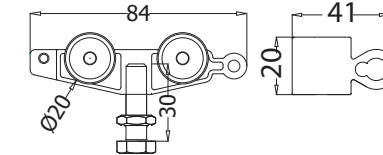

- V-1817**
- Stoppers Brixia

€▶A.136

xme425t

**V-1822**

€▶A.456

- 1 pezzo staffa per fissaggio a parete, (circa 1 pz ogni 400mm)
- 1 pcs bracket for wall installation (about 1 pcs each 400 mm)
- 1 Stück Winkelverbinder für Wandmontage (1 Stück je ca. 400 mm)

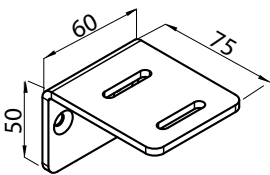

281P040

**V-1825**

€▶A.458

- 1 pezzo staffa per fissaggio a parete, (circa 1 pz ogni 400 mm)
- 1 pcs bracket for wall installation (about 1 pcs each 400 mm)
- 1 Stück Winkelverbinder für Wandmontage (1 Stück je ca. 400 mm)

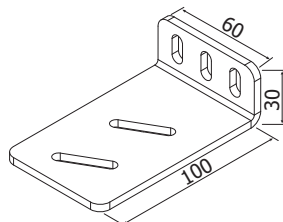

281P021

**V-1837**

€▶A.457

- 1 pezzo staffa per fissaggio a parete, (circa 1 pz ogni 400 mm)
- 1 pcs bracket for wall installation (about 1 pcs each 400 mm)
- 1 Stück Winkelverbinder für Wandmontage (1 Stück je ca. 400 mm)

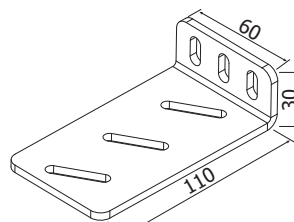

281P019

**V-1835**

€▶A.459

- 1 pezzo staffa per fissaggio a parete, (circa 1 pz ogni 400 mm)
- 1 pcs bracket for wall installation (about 1 pcs each 400 mm)
- 1 Stück Winkelverbinder für Wandmontage (1 Stück je ca. 400 mm)

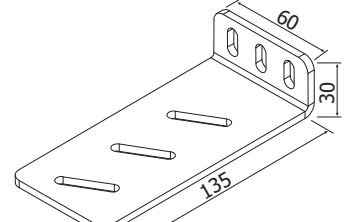

281P022

**V-2014-MIX**

€▶A.471

- Canalina per vetro fisso escluso guarnizioni
- U channel for fixed panel, gaskets not included
- U Profil für Seitenteil Dichtungen nicht inkl.

AN - IXE

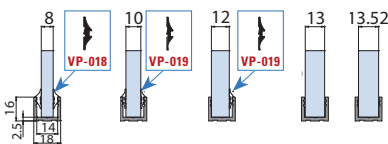

Cod.	Fin./Fin./Oberf.
V-2014-2000 mm	AN / IXE / NO
V-2014-3000 mm	AN / IXE / NO
V-2014-6000 mm	AN / IXE / NO

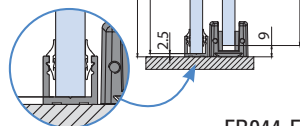

FB044-E

**LAV-TEL-BRIXIA**

€▶A.454

- Lavorazione optional per manutenzione Soft-close su binario telescopico
- Optional recess for maintenance of Soft-close device in the telescopic rails
- Optionale Ausfräsung für die Wartung von Soft-close stopper in den Teleskopischen Laufschienen

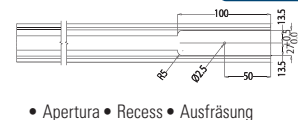

- Apertura • Recess • Ausfräsung

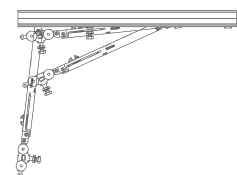

TELESCOPIC