

BRIXIA TELESCOPICO 2 VIE (OPTIONAL SOFT-CLOSE)



V-1820
TRASCINAMENTO SINCRONICO CON FUNE
SINCRO DRAGGING SYSTEM WITH CABLE
SINCRO MITNEHMER KIT MIT SEILZUG



V-1870
TRASCINAMENTO MECCANICO
MECHANICAL DRAGGING SYSTEM
MIT MECHANISCHEM MITNEHMER

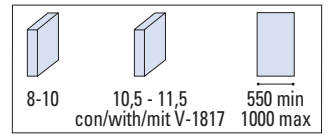

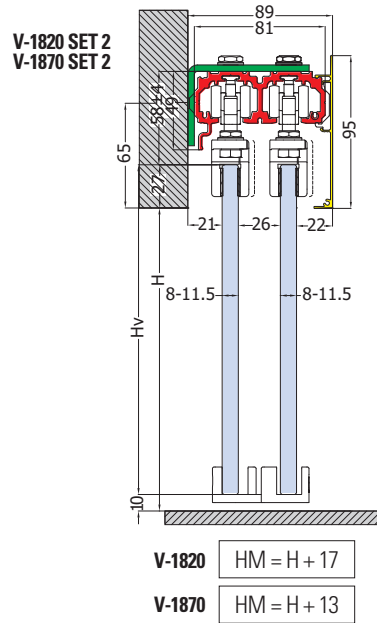
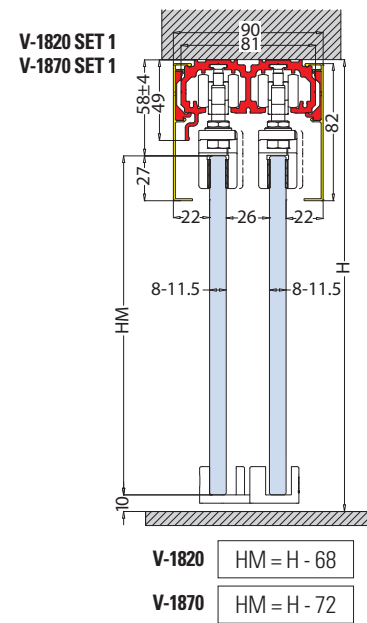
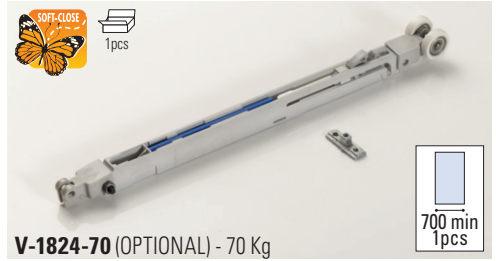
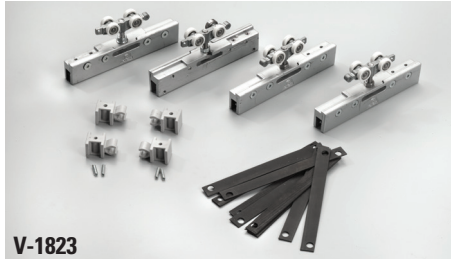
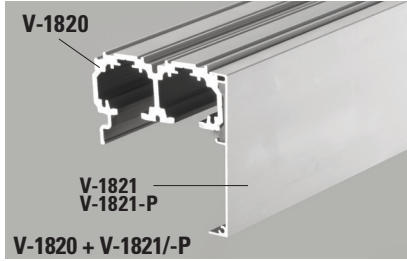
COMPONENTI / COMPONENTS / EINZELTEILE ▶ 126

V-1820
TRASCINAMENTO SINCRÒ CON FUNE
SINCRÒ DRAGGING SYSTEM WITH CABLE
SINCRÒ MITNEHMER KIT MIT SEILZUG



V-1870
TRASCINAMENTO MECCANICO
MECHANICAL DRAGGING SYSTEM
MIT MECHANISCHEM MITNEHMER

V-1820 / V-1870 SET 1

• Soffitto • Ceiling • Decke

- Sistema per 2 ante scorrevoli telescopiche con kit di trascinamento
- Telescopic sliding door system 2-ways with dragging mechanism
- Teleskopisches Schiebetürsystem 2-läufig mit Mitnehmer Kit

V-1820 / V-1870 SET 2

• Parete • Wall • Wand

- €▶A.424
- €▶A.426
- €▶A.425
- €▶A.427

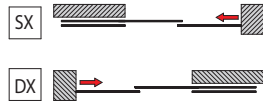
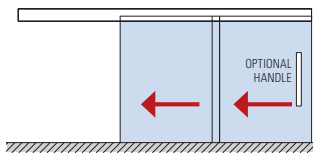

- Sinistra
• Left
• Links
- Destra
• Right
• Rechts

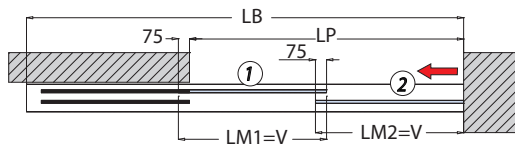
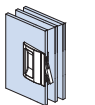

$$V = (PL + 150) / 2$$

$$LB = LP + V + 150$$

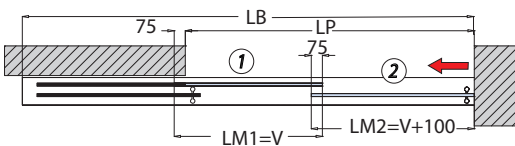
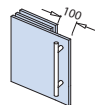

$$V = (PL + 50) / 2$$

$$LB = LP + V + 150$$

V-1820 SET 5

• Soffitto • Ceiling • Decke

€▶A.428

- Sistema per 2 ante scorrevoli "libere", fissaggio a soffitto
- Sliding door system 2-ways, for free movable panels, ceiling installation
- Schiebetürsystem 2-läufig, frei bewegliche, gegenläufige Ganzglasschiebetüren, Deckenmontage

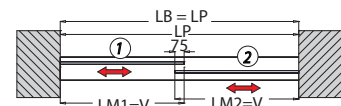
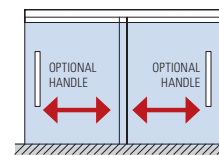

$$V = (PL + 75) / 2$$

xme425lm

Cod.	Fin./Fin./Oberf.	V-1820 / V-1870 SET 1 FX	V-1820 / V-1870 SET 1 MIS	V-1820 / V-1870 SET 2 FX	V-1820 / V-1870 SET 2 MIS	V-1820 / V-1870 SET 5 FX	V-1820 / V-1870 SET 5 MIS
V-1820 LB=2000 LB=3000 LB=4000 LB=6000	AN	1	-	1	-	1	-
V-1820-MIS LB= 1500→6000	AN	-	1	-	1	-	1
V-1821 / V-1821-P LB=2000 LB=3000 LB=4000 LB=6000	AN	2	-	1	-	2	-
V-1821-MIS / V-1821-P-MIS LB= 1500→6000	AN	-	2	-	1	-	2
V-1823	-	1	1	1	1	1	1
V-1826 (per set V-1820) V-1876 (per set V-1870)	-	1	1	1	1	-	-
V-1822 Staffa / Bracket / Winkelverbinder	-	-	-	1 x 400 mm	1 x 400 mm	-	-
V-1824-70 Soft-close (OPTIONAL)	-	(1)	(1)	(1)	(1)	(1) (2)	(1) (2)
V-1828-S Tappi per soffitto / Endcap for ceiling Endkappe für Decke (OPTIONAL)	AN	(1)	(1)	-	-	(1)	(1)
V-1828-P Tappi per parete / Endcap for wall / Endkappe für Wand (OPTIONAL)	AN	-	-	(1)	(1)	-	-

TELESCOPIC

V-1820 / V-1870 / V-1825 / V-1875 / V-1830 / V-1880 / V-1835 / V-1885 BRIXIA TELESCOPICO

COMPONENTI / COMPONENTS / EINZELTEILE

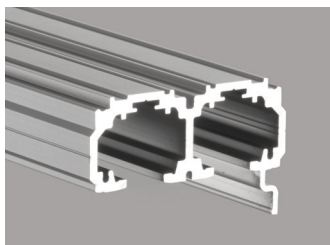

V-1820

- Binario Telescopico Brixia a 2 vie
- Track profile Telescopic Brixia 2 ways
- Laufschienenprofil Telescopisch Brixia 2-läufig

AN

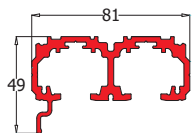
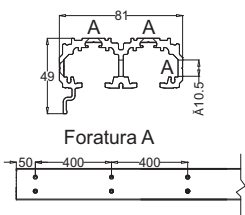

€▶A.441

xme425t

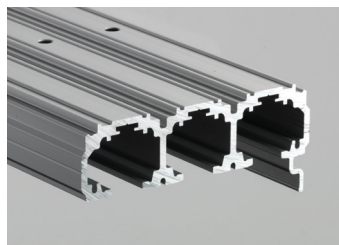

V-1830

- Binario Telescopico Brixia a 3 vie
- Track profile Telescopic Brixia 3 ways
- Laufschienenprofil Telescopisch Brixia 3-läufig

AN

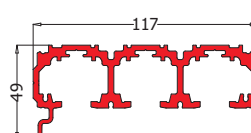
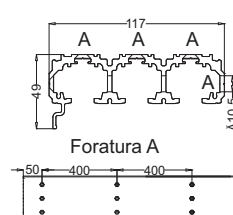

€▶A.442

xme425t



V-1821

- Veletta per binari Telescopici Brixia in alluminio anodizzato
- Cover profile anodised aluminium for Telescopic track profile Brixia
- Verkleidungsprofil aluminium für Laufschienenprofile Brixia

AN-IXE

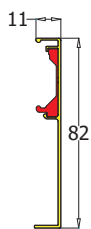

€▶A.443

xme425t



V-1821-P

- Veletta per binari telescopici BRIXIA set 2 a parete in alluminio anodizzato.
- Cover profile anodised aluminium for telescopic track profiles BRIXIA set 2 wall installation
- Verkleidungsprofil aluminium für Laufschienenprofile BRIXIA set 2 Wandmontage

AN-IXE



€▶A.444

xme425t



V-1834

- Profilo per vetro fisso per binario V-1820 / V-1830
- Side panel profile for track profile V-1820 / V-1830
- Seitenteilprofil für Laufschiene V-1820 / V-1830

AN

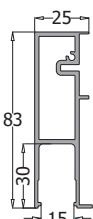

€▶A.445

xme425t

OPTIONAL	
VP-019-MT	VP-018-MT
1000 mm - 2000 mm - 3000 mm	
<ul style="list-style-type: none"> • Guarnizioni per sede vetro fisso • Gaskets for fixed glass • Dichtungen für Seitenteil 	

€▶A.455

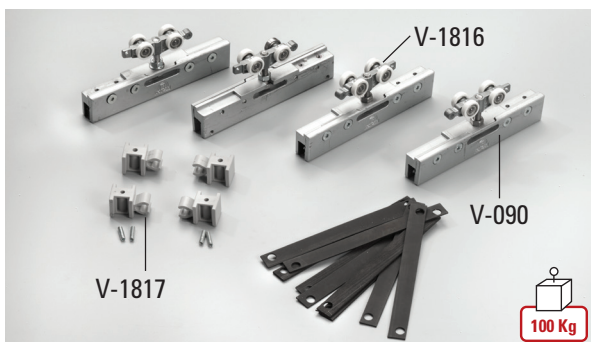

V-1823

- Set di accessori per 2 ante scorrevoli composto da: N°4 carrelli pinze, N°4 fermacarrello
- Sliding accessory set for 2 panels complete with: N°4 roller carriers - N°4 endstops
- Zubehör komplett mit: N°4 Klemm-Laufwagen, N°4 Endanschläge

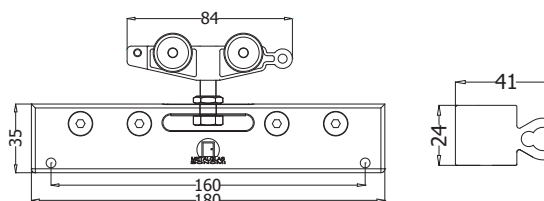

€▶A.446

xme425t

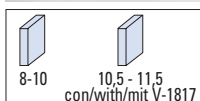

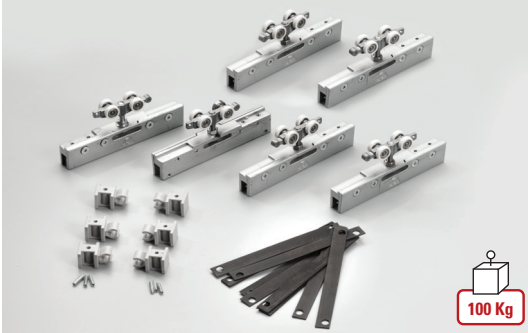

V-1833

- Set di accessori per 3 ante scorrevoli composto da: N°6 carrelli pinze, N°6 fermacarrello
- Sliding accessory set for 3 panels complete with: N°6 roller carriers - N°6 endstops
- Zubehör komplett mit: N°6 Klemm-Laufwagen, N°6 Endanschläge

€▶A.447

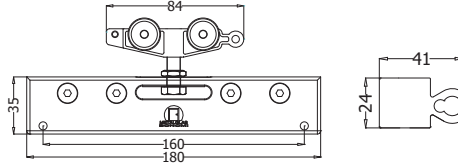

100 Kg

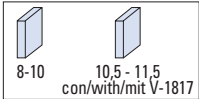

xme425t



V-1826 DX-SX

- Kit morsetti trascinamento Sincro con fune 2 ante scorrevoli compreso di guide a pavimento V-012 e V-099-C
- Dragging kit Sincro with cable for 2 sliding panels, including floor guides V-012 and V-099-C
- Mitnehmer kit Sincro mit Seilzug für 2 bewegliche Schiebetüren mit Bodenführungen V-012 und V-099-C

€▶A.448

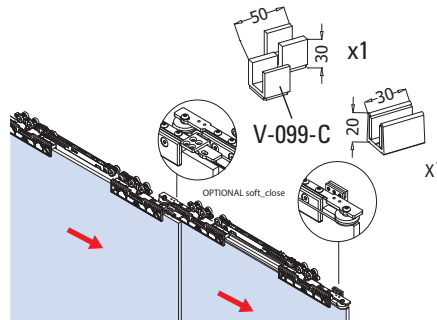
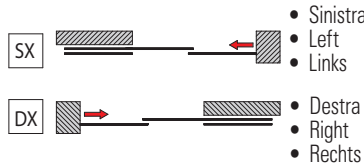

xme425lm

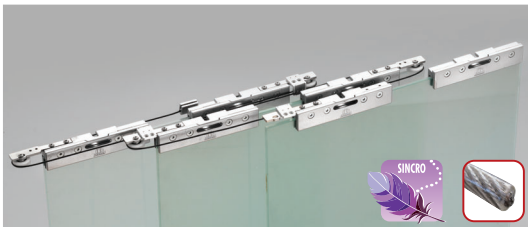

V-1836 DX-SX

- Kit morsetti trascinamento Sincro con fune 3 ante scorrevoli compreso di guide a pavimento V-012 e V-099-C
- Dragging kit Sincro with cable for 3 sliding panels, including floor guides V-012 and V-099-C
- Mitnehmer kit Sincro mit Seilzug für 3 bewegliche Schiebetüren mit Bodenführungen V-012 und V-099-C

€▶A.450

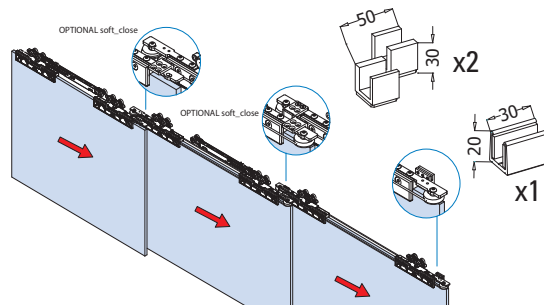
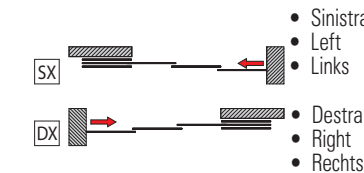

xme425pq



V-1876 DX-SX

- Kit morsetti trascinamento meccanico per 2 ante scorrevoli compreso di guide a pavimento V-012 e V-099-C
- Dragging kit for 2 sliding panels, including floor guides V-012 and V-099-C
- Mitnehmer kit für 2 bewegliche Schiebetüren mit Bodenführungen V-012 und V-099-C

€▶A.449

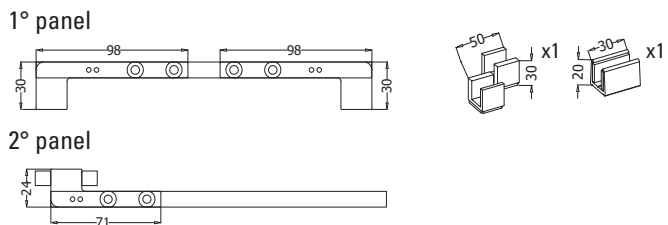
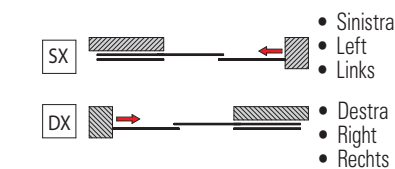

xme425t

TELESCOPIC

V-1820 / V-1870 / V-1825 / V-1875 / V-1830 / V-1880 / V-1835 / V-1885 BRIXIA TELESCOPICO

COMPONENTI / COMPONENTS / EINZELTEILE



V-1886 DX-SX

- Kit morsetti trascinamento meccanico per 3 ante scorrevoli compreso di guide a pavimento V-012 e V-099-C
- Dragging kit for 3 sliding panels, including floor guides V-012 and V-099-C
- Mitnehmer kit für 3 bewegliche Schiebetüren mit Bodenführungen V-012 und V-099-C

€▶A.451

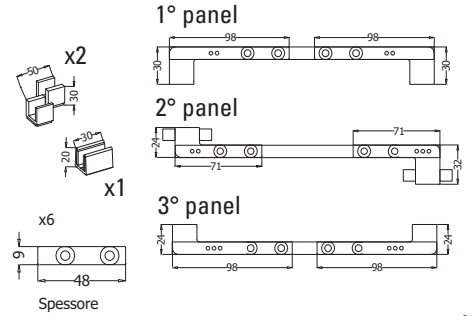
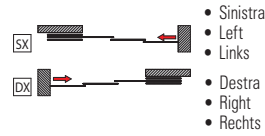

xme425t

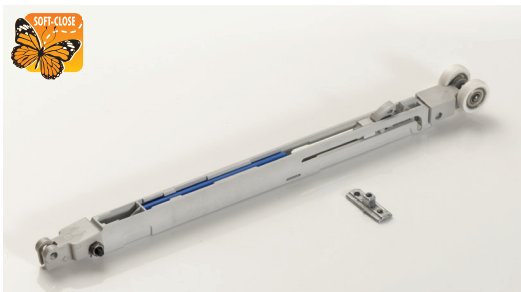

V-1824-70 Kg

- Optional stopper Soft-close (in chiusura) per scorrevole Telescopico V-1820, V-1830
- Optional stopper with Soft-close mechanism (only closing) for sliding system Telescopico V-1820, V-1830
- Optional stopper mit Soft-close (nur in Schliessrichtung) für Telescopisch V-1820, V-1830

€▶A.452

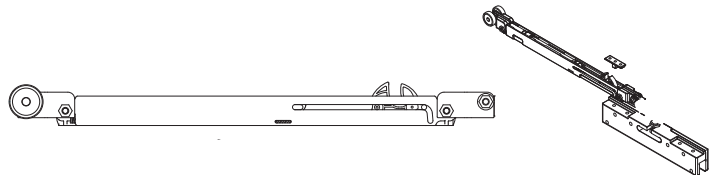

xme425t

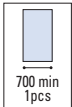

V-1828-S

- Paio tappi finali per sistema V-1820/ V-1870
- Pair endcaps for system V-1820/ V-1870
- Paar Endkappen für System V-1820/ V-1870

AN-IXE

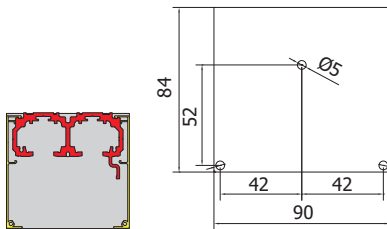

281p028

V-1828-P

- Paio tappi finali per sistema V-1820/ V-1870
- Pair endcaps for system V-1820/ V-1870
- Paar Endkappen für System V-1820/ V-1870

AN-IXE

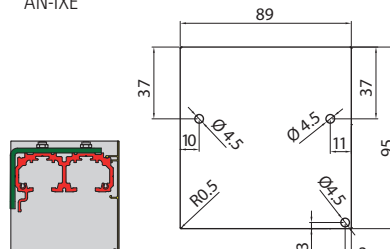

281p042

V-1828-F

- Paio tappi finali per sistema V-1825/ V-1875
- Pair endcaps for system V-1825/ V-1875
- Paar Endkappen für System V-1825/ V-1875

AN-IXE

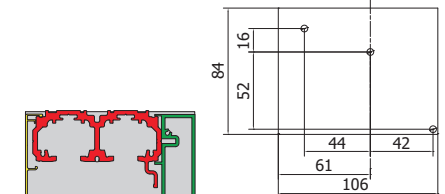

281p030

V-1838-S

- Paio tappi finali per sistema V-1830/ V-1880
- Pair endcaps for system V-1830/ V-1880
- Paar Endkappen für System V-1830/ V-1880

AN-IXE

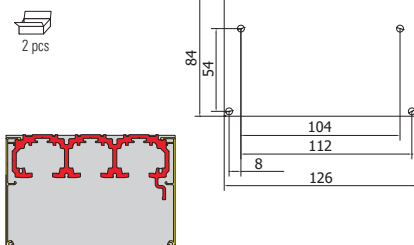

281P031

V-1838-P

- Paio tappi finali per sistema V-1830/ V-1880
- Pair endcaps for system V-1830/ V-1880
- Paar Endkappen für System V-1830/ V-1880

AN-IXE

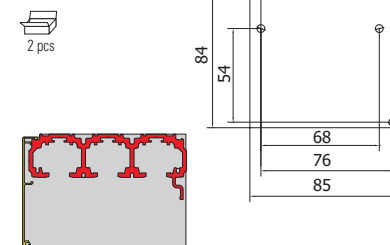

281P032

V-1839

- Paio tappi finali per sistema V-1835/ V-1885
- Pair endcaps for system V-1835/ V-1885
- Paar Endkappen für System V-1835/ V-1885

AN-IXE

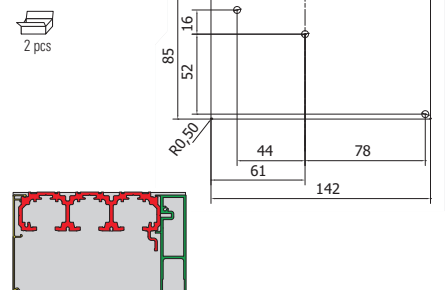

281P033



V-099-C DX / V-099-C SX

- Doppia guida a pavimento destra o sinistra
- Double floor guide right or left
- Doppel Bodenführung rechts oder links

€▶A.469

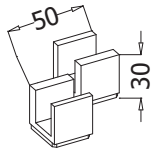
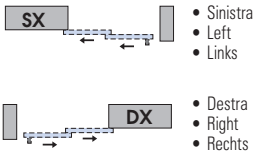

xme425t



V-090-T

- Pinza
- Clamp
- Klemmschuh

€▶A.466

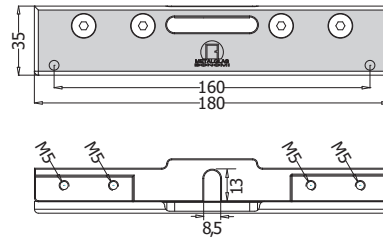
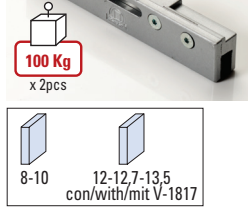

V-1817-A / V-1817-B / V-1817-C

- Kit spessori vetro OPTIONAL 12 - 12,7 - 13,5
- Kit spacers for glass thickness OPTIONAL 12 - 12,7 - 13,5
- Kit Distanzscheiben für Glasdicke OPTIONAL 12 - 12,7 - 13,5

€▶A.467

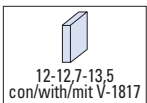
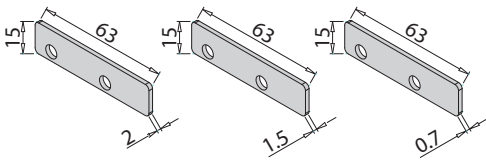

xme425t



V-1816

- Carrello Brixia Heavy
- Carrier Brixia Heavy
- Laufwagen Brixia Heavy

€▶A.470

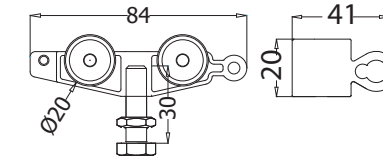

- V-1817**
- Stoppers Brixia

€▶A.136

xme425t

V-1822

€▶A.456

- 1 pezzo staffa per fissaggio a parete, (circa 1 pz ogni 400mm)
- 1 pcs bracket for wall installation (about 1 pcs each 400 mm)
- 1 Stück Winkelverbinder für Wandmontage (1 Stück je ca. 400 mm)

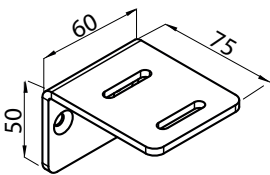

281P040

V-1825

€▶A.458

- 1 pezzo staffa per fissaggio a parete, (circa 1 pz ogni 400 mm)
- 1 pcs bracket for wall installation (about 1 pcs each 400 mm)
- 1 Stück Winkelverbinder für Wandmontage (1 Stück je ca. 400 mm)

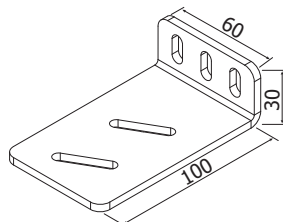

281P021

V-1837

€▶A.457

- 1 pezzo staffa per fissaggio a parete, (circa 1 pz ogni 400 mm)
- 1 pcs bracket for wall installation (about 1 pcs each 400 mm)
- 1 Stück Winkelverbinder für Wandmontage (1 Stück je ca. 400 mm)

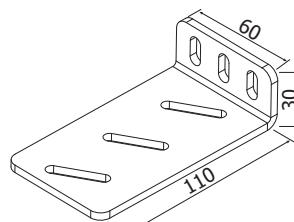

281P019

V-1835

€▶A.459

- 1 pezzo staffa per fissaggio a parete, (circa 1 pz ogni 400 mm)
- 1 pcs bracket for wall installation (about 1 pcs each 400 mm)
- 1 Stück Winkelverbinder für Wandmontage (1 Stück je ca. 400 mm)

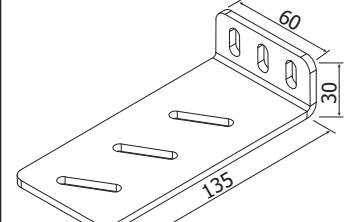

281P022

V-2014-MIX

€▶A.471

- Canalina per vetro fisso escluso guarnizioni
- U channel for fixed panel, gaskets not included
- U Profil für Seitenteil Dichtungen nicht inkl.

AN - IXE

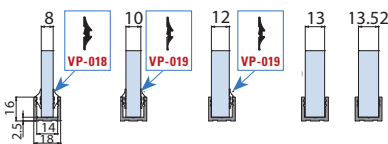

Cod.	Fin./Fin./Oberf.
V-2014-2000 mm	AN / IXE / NO
V-2014-3000 mm	AN / IXE / NO
V-2014-6000 mm	AN / IXE / NO

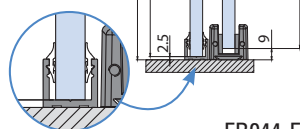

FB044-E

LAV-TEL-BRIXIA

€▶A.454

- Lavorazione optional per manutenzione Soft-close su binario telescopico
- Optional recess for maintenance of Soft-close device in the telescopic rails
- Optionale Ausfräsung für die Wartung von Soft-close stopper in den Teleskopischen Laufschienen

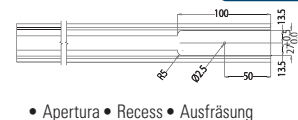

- Apertura • Recess • Ausfräsung

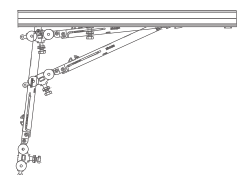

TELESCOPIC