

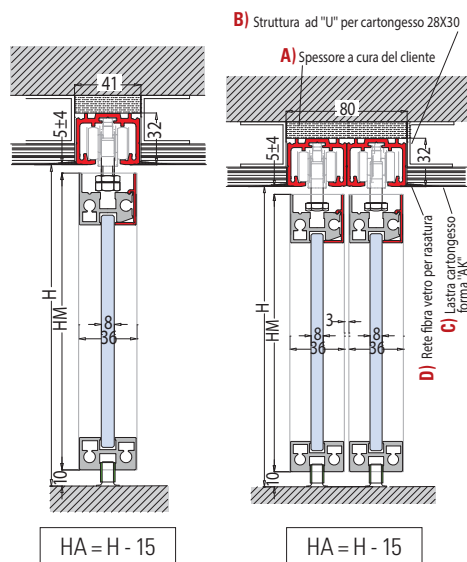

BRIXIA INVISIBLE (OPTIONAL SOFT-CLOSE)

V-1815

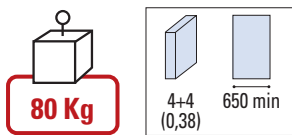

V-1815 SET 1

€▶A.229

V-1815 SET 2

€▶A.230

V-1815 SET 5

€▶A.231

V-1815-F SET 1

€▶A.232

V-1815-F SET 2

€▶A.233

V-1815-F SET 5

€▶A.234

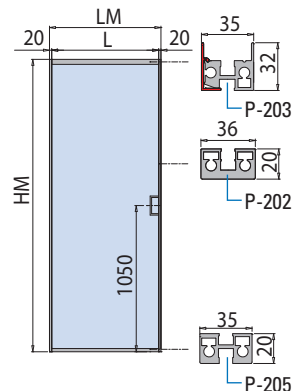
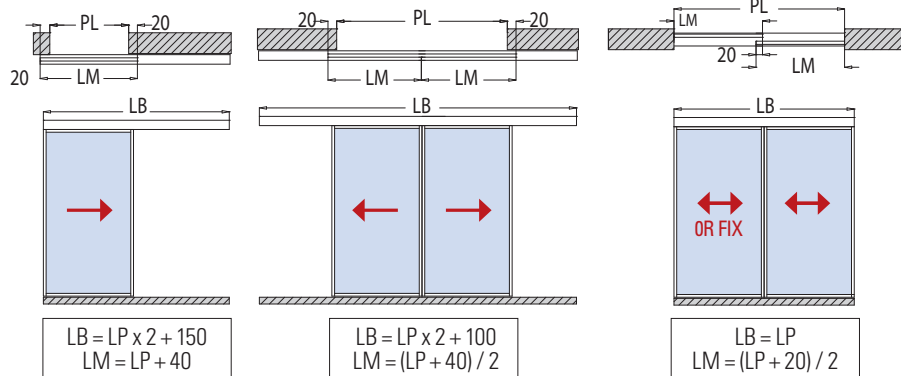

V-1815-F con / with / mit Soft-close

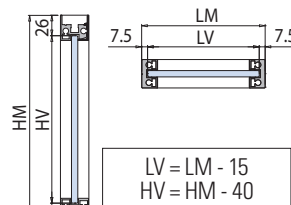

xme425uv

COMPONENTI / COMPONENTS / EINZELTEILE ▶ 87

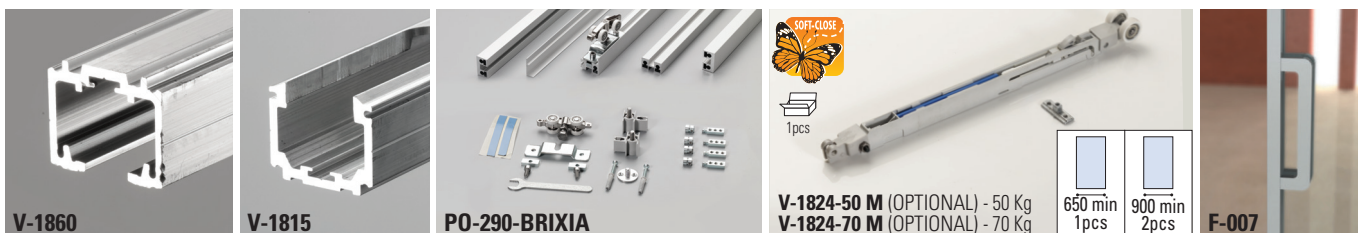

Cod.	Fin. / Fin. Oberf.	SET 1 FIX		SET 1-MIS		SET 2 FIX		SET 2-MIS		SET 5 FIX		SET 5-MIS	
		V-1815	V-1815-F	V-1815	V-1815-F	V-1815	V-1815-F	V-1815	V-1815-F	V-1815	V-1815-F	V-1815	V-1815-F
V-1860 LB=2000 LB=3000 LB=4000 LB=6000	AN	1	-	-	-	1	-	-	-	2	-	-	-
V-1860-MIS LB= 1500→6000	AN	-	-	1	-	-	-	1	-	-	-	2	-
V-1815OPTIONAL LB=2000 LB=3000 LB=4000 LB=6000	AN	-	1	-	-	-	1	-	-	-	2	-	-
V-1815-MIS OPTIONAL LB= 1500→6000	AN	-	-	-	1	-	-	-	1	-	-	-	2
PO-290 - BRIXIA	AN	1	1	1	1	2	2	2	2	2	2	2	2
V-1824-70 M / V-1824-50 M Soft-close (OPTIONAL)	-	-	(1) (2)	-	(1) (2)	-	(2) (4)	-	(2) (4)	-	(2) (4)	-	(2) (4)
F-007 Maniglie / Handles / Griffe (OPTIONAL)	AN	(1)	(1)	(1)	(1)	(2)	(2)	(2)	(2)	(2)	(2)	(2)	(2)

V-1815 BRIXIA INVISIBLE (OPTIONAL SOFT-CLOSE)

COMPONENTI / COMPONENTS / EINZELTEILE

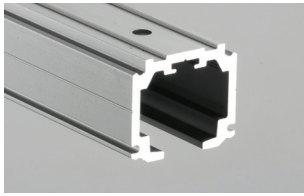

V-1860 €▶A.235

- Binario Scorrevole BRIXIA HEAVY
- Track profile BRIXIA HEAVY
- Laufschienenprofil BRIXIA HEAVY AN

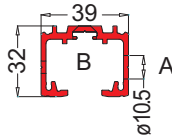
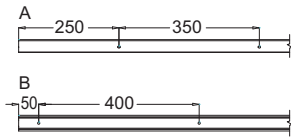

xme425i

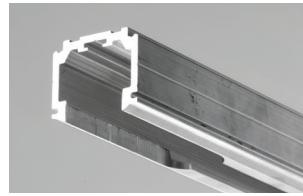

V-1815 €▶A.236

- Binario Scorrevole con fresatura per inserimento carrelli e stopper Soft-close
- Track profile with recess for Soft-close stoppers and carriers in and out
- Laufschienenprofil mit Ausfräsung mit ein Ausfahren für Laufwerk und Soft-close stopper AN

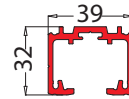
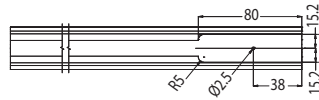

xme425uv



V-1824-70 M Kg / V-1824-50 M Kg

- Optional stopper Soft-close per sistema V-1815-F
- Optional stopper with Soft-close mechanism for system V-1815-F
- Optional Stopper mit Soft-close für System V-1815-F

€▶A.239
€▶A.240

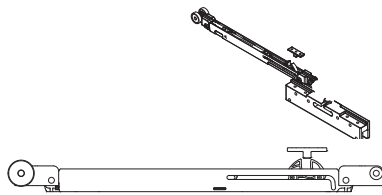
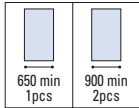

P-F25

xme425uv



PO-290-BRIXIA

- Profili per anta intelaiata max 1200 x 3000 mm con carrelli e stopper
- Profiles for aluminium panel max 1200x3000 mm with carriages and stoppers
- Flügelrahmen aus Aluminium max 1200x3000 mm mit Laufwagen und Stopper AN

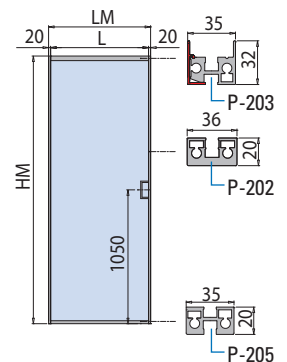

xme270

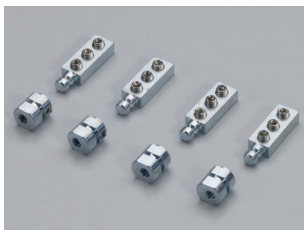

P-F25 €▶A.251

- Ferramenta necessaria per assemblare n.1 anta intelaiata PO-290
- Fixing materials to assembly one aluminium panel PO-290
- Befestigungsmaterial für 1 set Flügelrahmen PO-290

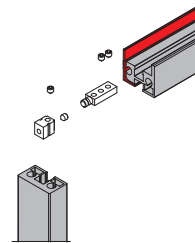
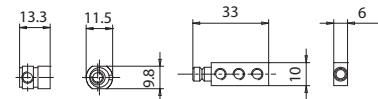

xme270

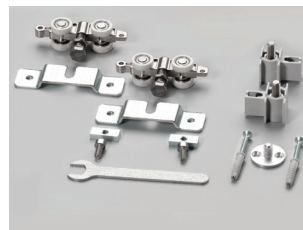

PO-292-BRIXIA €▶A.249

- Set accessori per 1 anta scorrevole intelaiata composto da: n.2 carrellini n.2 stoppers - n.1 oliva a pavimento
- Accessory set for 1 sliding door with aluminium panel containing: N° 2 carriers N° 2 stoppers N° 1 floor guide
- Zubehör Set komplett für 1 Schiebetür mit Aluminium Flügelrahmen bestehend aus: N° 2 Laufwagen, N° 2 Stopper, N° 1 Bodenführung

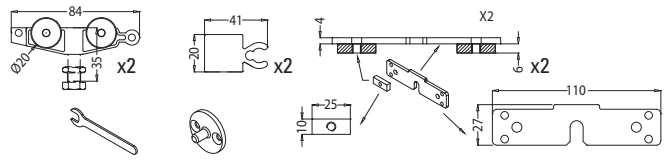

xme503



P-203

- Traverso orizzontale superiore
- Top horizontal profile
- Oberes horizontalprofil AN

€▶A.243
€▶A.246

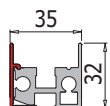

xme270a

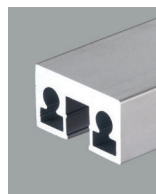

P-202

- Montante verticale
- Vertical profile
- Vertikalprofil AN

€▶A.242
€▶A.245

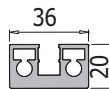

xme270a



P-205

- Traverso orizzontale inferiore
- Bottom horizontal profile
- Unteres horizontalprofil AN

€▶A.244
€▶A.247

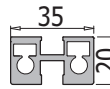

xme270a



€▶A.238

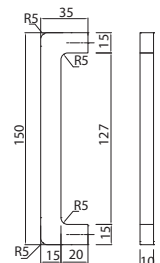

F-007

- Paio maniglie ad incollaggio in alluminio anodizzato naturale
- Pair sliding handle with self adhesive fixing in anodised aluminium
- Paar Schiebegriffe aus eloxiertem Aluminium Selbstklebend

F-007