

# VD 1510 | VD 1511

Freitragendes Vordachsystem

Self-Supporting Canopy System



Pauli + Sohn





# Übersicht VD 1510 | VD 1511

---

overview VD 1510 | VD 1511

Allgemein general .....	5
VD 1510 .....	9
VD 1511 .....	13
Montageanleitungen assembly instructions .....	20
Wärmedämmkonsole 1519 thermal insulation console 1519.....	22





## Sonnige Aussichten mit der AbZ

sunny outlook with the AbZ = National Technical Approval

MADE  
IN  
GERMANY



## Allgemein general

VD 1510  
VD 1511

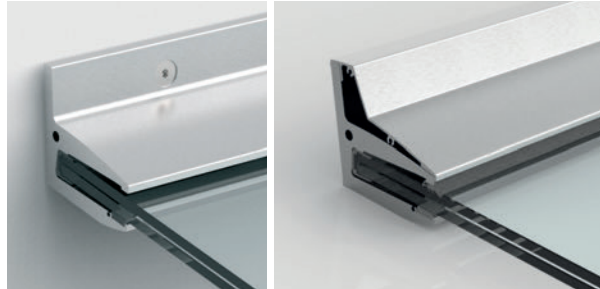

### Freitragendes Glasvordach mit AbZ

Avantgardistisches Design und ein hohes Maß an Sicherheit zeichnen dieses hochwertige Vordach aus. Mit dem Vordachsystem VD 1510/1511 inkl. neuer AbZ von Pauli + Sohn ist es möglich, theoretisch unendlich viele Glasscheiben einseitig an der Wand zu befestigen, ohne eine weitere Befestigung im vorderen Bereich zu benötigen. Die Glasscheibe wird mittels einer Wandhalterung – ohne Zugstangen – am Untergrund befestigt. Die Wandhalterung, bestehend aus einem Aluminiumprofil, tritt dezent in den Hintergrund.

Cantilever glass canopy with AbZ = National Technical Approval. Its avant-garde design and a high degree of safety defines this high quality canopy. With the canopy system VD 1510 /1511 with its National Technical Approval, it is theoretically possible to mount an infinite number of glass panels to the wall, without the requirement any further attachment to the front of the panels. The glass panel is fixed by means of a wall mounting profile without tie rods or other supporting hardware. The wall mounting profile is made of aluminum and subtly blends into the background.

### Komprimierte Fakten aus der AbZ:

- 17,52 mm VSG aus TVG mit SentryGlas®-Zwischenlage nach AbZ 70.3-170 oder AbZ 70.3-143 (**ACHTUNG:** Bitte die Unterschiede in der Statik beachten)
- Vielfältige Modellscheiben sowie Glasausschnitte sind möglich
- Dachneigung 10° (darüber hinaus ist es möglich, das Wandprofil um bis zu 9° nach oben geneigt einzubauen)

Es dürfen mehrere Profile aneinandergereiht werden, um eine Scheibe aufzunehmen (z.B. Profil 1 B = 1400 und 2 B = 1600 zur Aufnahme einer Scheibe B = 2998 mm). Hierbei ist darauf zu achten, dass die maximale Scheibenbreite nicht überschritten wird und alle Druckstempel und die beiden äußeren Fixierelemente zum Einsatz kommen.

Profitieren Sie von unserem Wissen und unserem Erfahrungsschatz rund um den konstruktiven Glasbau. Unsere Experten von Pauli + Sohn beraten Sie kompetent und immer aktuell.

### Compressed facts of the AbZ = National Technical Approval:

- 17.52 mm LSG from heat strengthened glass with SentryGlas® interlayer according to AbZ 70.3-170 or AbZ 70.3-143 (**ATTENTION:** please observe the differences in the static calculations)
- Versatile panels as well as glass cutouts are possible
- Roof pitch 10° (In addition, it is possible to adjust the wall profile to be inclined upwards by 9°)

Several profiles may be mounted in line to support one long panel (For example, profile 1 B = 1400 and profile 2 B = 1600 to support a glass panel B = 2998 mm). Please make sure that the maximum width is not exceeded and that all contact fixtures and the two outer fixing elements are used.

Benefit from our knowledge and our experience with constructive glass building. Our experts from Pauli + Sohn will always advise you competently and up-to-date

AbZ = German National Technical Approval  
Statik = static calculation available



## Freitragendes Vordachsystem

self-supporting canopy system



VD1510



## Freitragendes Vordachsystem mit verdeckter Befestigung

self-supporting canopy system with concealed mounting fasteners

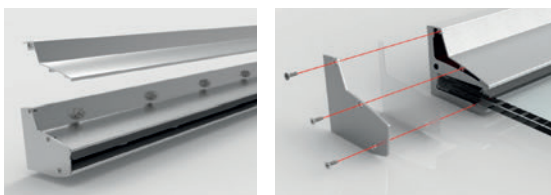

### VD1511

Vordach mit verdeckter Befestigung  
cantilever canopy with concealed mounting fasteners





## VD1510

MADE  
IN  
GERMANY



- Keine Zugstangen erforderlich
- Einfache Montage
- Glasbreite bis 3000 mm
- 17,52 mm VSG aus TVG mit SentryGlas®-Zwischenlage
- Max. 1100 mm Ausladung
- Bis zu 3,98 kN/m<sup>2</sup> Last
- Mehrere Wandprofile können in Reihe montiert werden
- Keine Randausschnitte im Glas erforderlich
- Nur die untere Glasscheibe im Verbund benötigt Glasbohrungen für die Fixierelemente (keine Gefahr von Bohrungsversatz im Verbund)

- connector rods are not required
- easy assembly
- glass width max. 3000 mm
- 17.52 mm LSG made of HSG with SentryGlas® interlayer
- max. 1100 mm cantilever outspan
- up to 3,98 kN/m<sup>2</sup> load
- numerous profiles can be mounted in a series
- no edge recesses in the glass panel are required
- only the lower glass panel of the laminate requires holes for securing (no risk of drill offset in the laminate)



## Vordach-Wandprofil 1510 | canopy-wall-profile 1510

Material: Aluminium | material: aluminium

Art.-Nr. art. no.		Befestigungsbohrung fixation holes	Ausladung outspan	Glasbreite glass width	Gesamtbreite total width
1510E6EV1-17-1400	17,52 mm	7x	≤1100 mm	1398 mm	1407 mm
1510E6EV1-17-1600	17,52 mm	8x	≤1100 mm	1598 mm	1607 mm
1510E6EV1-17-2000	17,52 mm	10x	≤1100 mm	1998 mm	2007 mm
1510E6EV1-17-2400	17,52 mm	12x	≤1100 mm	2398 mm	2407 mm

### Set-Inhalt | set contents

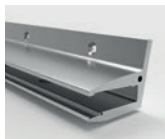

1x  
Wandprofil  
wall profile



1x  
oberes Verglasungsprofil  
upper glazing profile

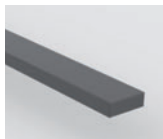

1x  
Auflageprofil  
contact profile

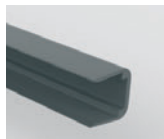

1x  
Kantenschutzprofil  
edge protection profile



2x  
Klebeпад  
links/rechts  
adhesive pad  
left/right



2x  
Endkappe  
inkl. Schrauben  
links/rechts  
end cap screws incl.  
left/right



3-4x  
Druckstempel  
glass support fastener



2x  
Fixierelement mit  
Glassicherung  
Glass securing  
fastener

### Befestigungszubehör | fixation accessories



S7991A2D10x40  
(Senkkopfschraube)  
(countersink)



1510-11VA  
(Verbindungsstift)  
(connecting stud)



1501KL-300  
(FIS V 300T)  
(Hochleistungsmörtel)  
(high performance mortar)



Z059  
(Stirnlochschlüssel)  
(adjustable face spanner)



1980KU-20x85  
(FIS H 20x85 K)  
(Siebhülse)  
(mesh sleeve)



1979ST8-M10  
(FIS E M10)  
(Innengewindeanker)  
(internally threaded plug)



1024520CTP (10 l)  
(Montage- und Gleitmittel)  
(assembly lubricant)



102476CTP (0,5 l)  
(Hochleistungs-Montage- und Gleitmittel)  
(assembly lubricant)

AbZ = German National Technical Approval  
BD = Rated diagrams available

 Oberfläche | surface  
E6EV1

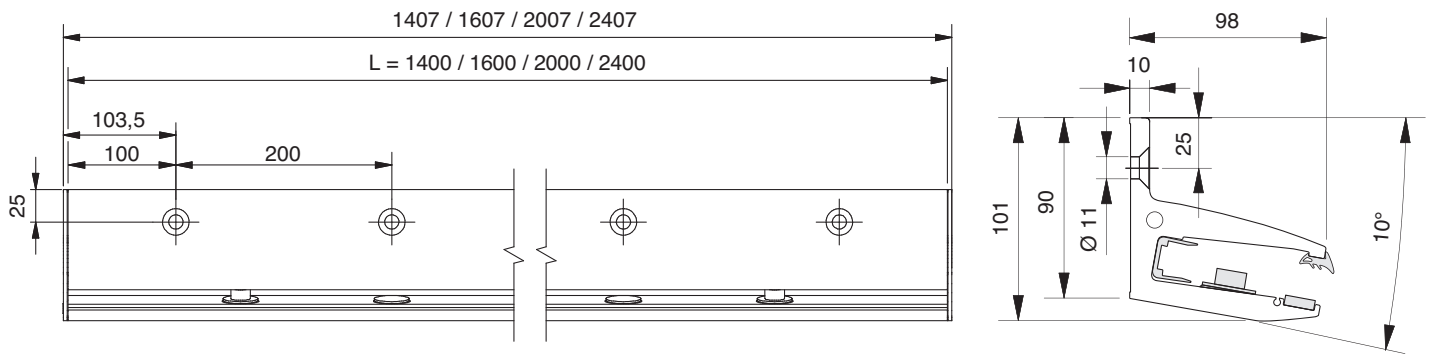

Glasbearbeitung | glass processing

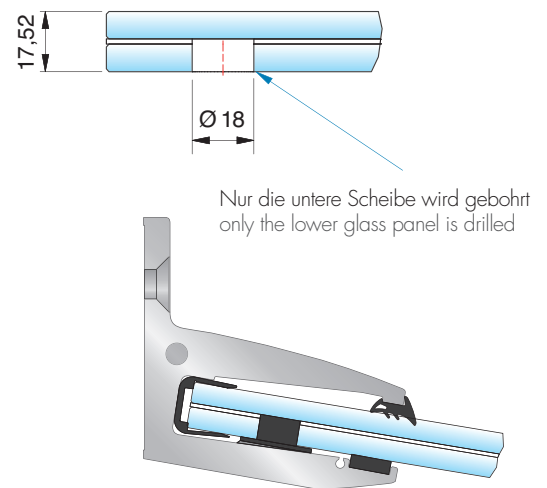
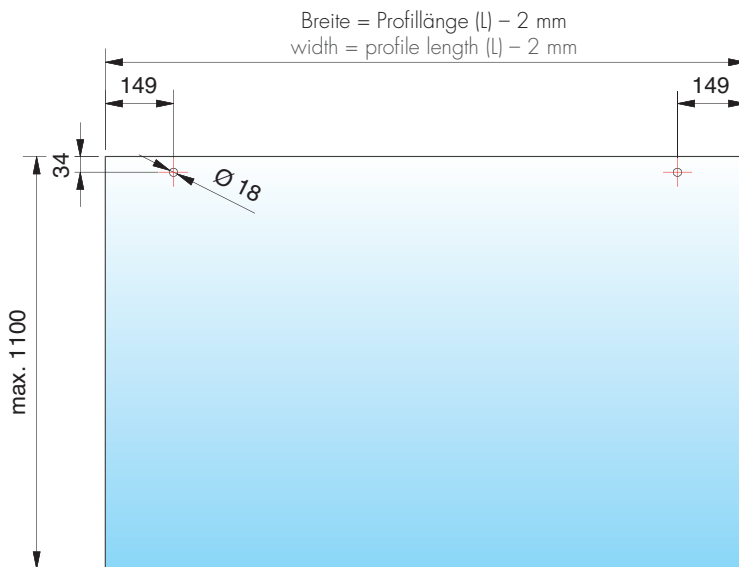

Sollte Ihr Bauvorhaben eine Kombination aus mehreren Vordächern erfordern, bieten wir Ihnen folgende Kombinationsbeispiele an:  
If your building project requires a combination of several canopies, we offer the following combination examples:

Vordach-Wandprofil Kombinationsets 1510 | canopy-wall-profile combination sets 1510

Art.-Nr. art. no.		Breite in mm width in mm	Bestehend aus comprised of	Inklusive Verbindungsstift connecting stud included
1510E6EV1-17-1800	17,52 mm	1800	2 x 900 mm	1 x 1510-11VA
1510E6EV1-17-2300	17,52 mm	2300	900 + 1400 mm	1 x 1510-11VA
1510E6EV1-17-2500	17,52 mm	2500	900 + 1600 mm	1 x 1510-11VA
1510E6EV1-17-2700	17,52 mm	2700	3 x 900 mm	2 x 1510-11VA
1510E6EV1-17-2800	17,52 mm	2800	2 x 1400 mm	1 x 1510-11VA
1510E6EV1-17-2900	17,52 mm	2900	900 + 2000 mm	1 x 1510-11VA
1510E6EV1-17-3000	17,52 mm	3000	1400 + 1600 mm	1 x 1510-11VA



VD1511

MADE  
IN  
GERMANY



- Keine Zugstangen erforderlich
- Einfache Montage und verdeckte Befestigung
- Glasbreite bis 3000 mm
- 17,52 mm VSG aus TVG mit SentryGlas®-Zwischenlage
- Max. 1100 mm Ausladung
- Bis zu 3,98 kN/m<sup>2</sup> Last
- Mehrere Wandprofile können in Reihe montiert werden
- Keine Randausschnitte im Glas erforderlich
- Nur die untere Glasscheibe im Verbund benötigt Glasbohrungen für die Fixierelemente (keine Gefahr von Bohrungsversatz im Verbund)

- connector rods are not required
- easy assembly and concealed mounting fasteners
- glass width max. 3000 mm
- 17.52 mm LSG made of HSG with SentryGlas® interlayer
- max. 1100 mm cantilever outspan
- up to 3,98 kN/m<sup>2</sup> load
- numerous profiles can be mounted in a series
- no edge recesses in the glass panel are required
- only the lower glass panel of the laminate requires holes for securing (no risk of drill offset in the laminate)

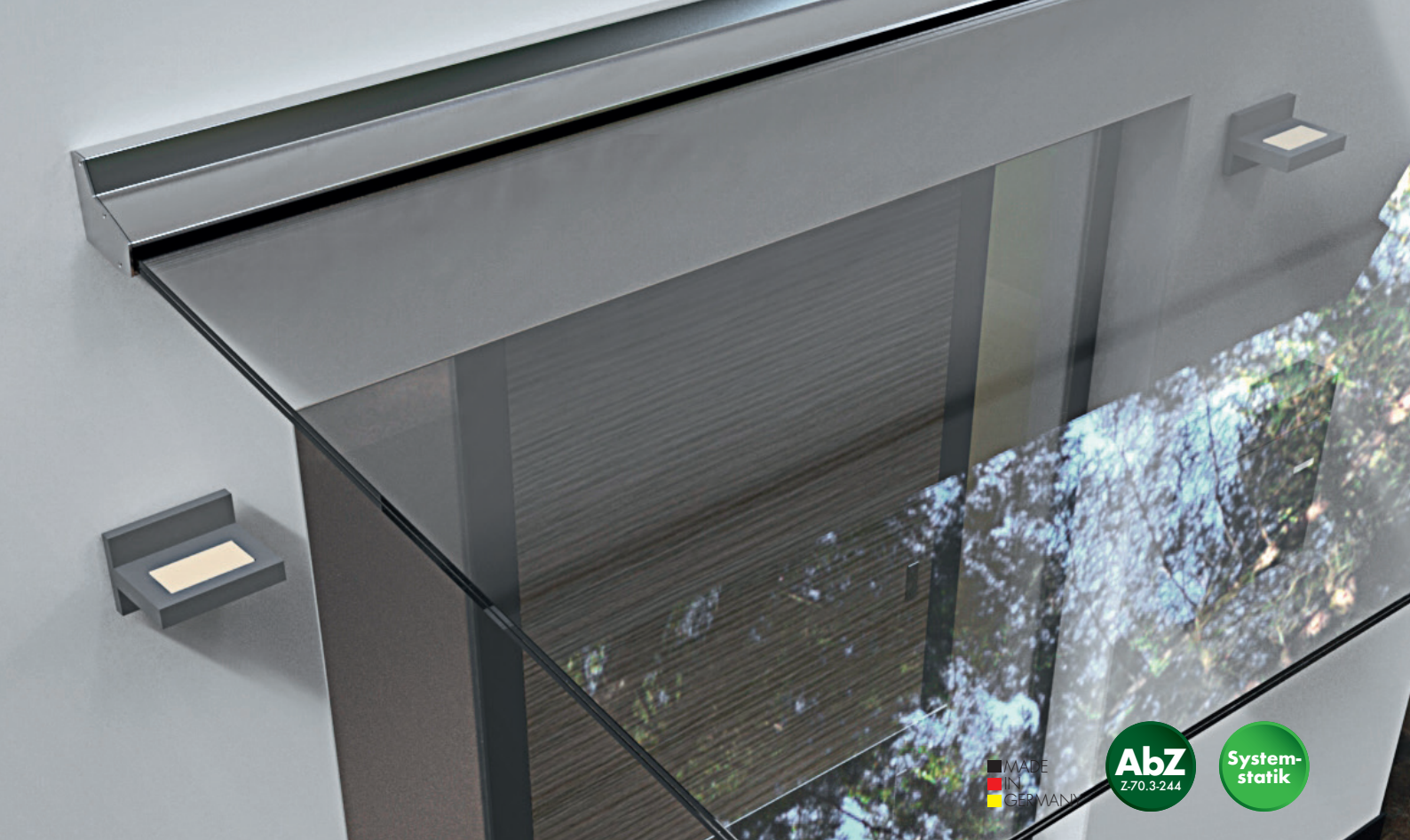







## Vordach-Wandprofil 1511-17 | Canopy wall profile 1511-17

Material: Aluminium | Material: Aluminium

Art.-Nr. Art. no.		Befestigungsbohrung Fixation holes	Ausladung Outspan	Glasbreite Glass width	Gesamtbreite Total width
1511E6EV1-17-1400	17,52 mm	7x	≤1100 mm	1398 mm	1407 mm
1511E6EV1-17-1600	17,52 mm	8x	≤1100 mm	1598 mm	1607 mm
1511E6EV1-17-1800	17,52 mm	9x	≤1100 mm	1798 mm	1807 mm
1511E6EV1-17-2000	17,52 mm	10x	≤1100 mm	1998 mm	2007 mm
1511E6EV1-17-2400	17,52 mm	12x	≤1100 mm	2398 mm	2407 mm

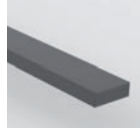
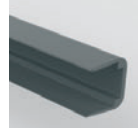
Auch in RAL erhältlich | Also available in RAL

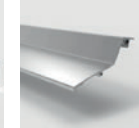
### Set-Inhalt | Set contents

								
1x Wandprofil wall profile	1x oberes Verglasungsprofil upper glazing profile	1x Auflageprofil contact profile	1x Kantenschutzprofil edge protection profile	2x Klebeпад links/rechts adhesive pad left/right	2x Endkappe inkl. Schrauben links/rechts end cap screws incl. left/right	1x Abdeckblech cladding	3-4x Druckstempel glass support fastener	2x Fixierelement mit Glassicherung glass securing fastener

### Befestigungszubehör | Fixation accessories

	1970-1VA (Ankerstange) (anchor bolt)		1510-11VA (Verbindungsstift) (connecting stud)		1501KL-300 (FIS V 300T) (Hochleistungsmörtel) (high performance mortar)		Z059 (Stirnlochschlüssel) (adjustable face spanner)
	1980 (Siebhülse) (mesh sleeve)		1024520CTP (10 l) (Montage- und Gleitmittel) (assembly lubricant)		102476CTP (0,5 l) (Hochleistungs-Montage- und Gleitmittel) (assembly lubricant)	Oberfläche   surface	

AbZ = German National Technical Approval

E6EV1

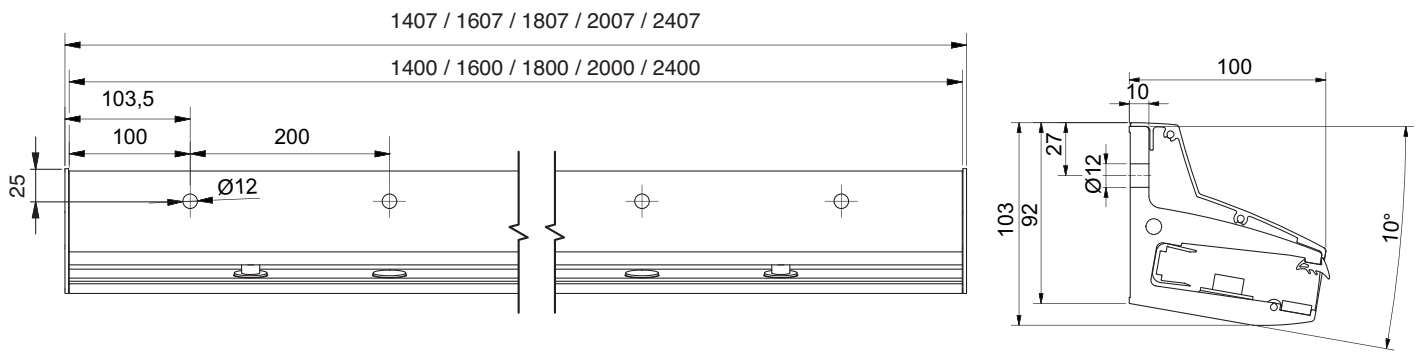

Glasbearbeitung | glass processing

Breite = Profillänge (L) - 2 mm  
width = profile length (L) - 2 mm

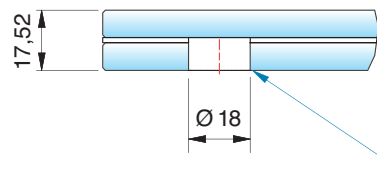
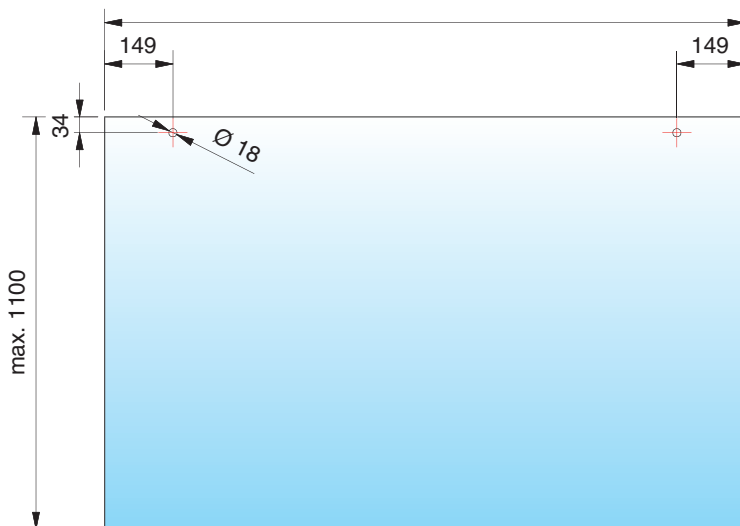

Nur die untere Scheibe wird gebohrt  
only the lower glass panel is drilled

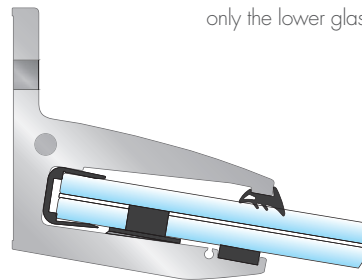

Sollte Ihr Bauvorhaben eine Kombination aus mehreren Vordächern erfordern, bieten wir Ihnen folgende Kombinationsbeispiele an:  
If your building project requires a combination of several canopies, we offer the following combination examples:

Vordach-Wandprofil Kombinationsets 1511-17 | canopy wall profile combination sets 1511-17

Art.-Nr. art. no.		Breite in mm width in mm	Bestehend aus comprised of	Inklusive Verbindungsstift connecting stud included
1511E6EV1-17-1800	17,52 mm	1800	2 x 900 mm	1 x 1510-11VA
1511E6EV1-17-2300	17,52 mm	2300	900 + 1400 mm	1 x 1510-11VA
1511E6EV1-17-2500	17,52 mm	2500	900 + 1600 mm	1 x 1510-11VA
1511E6EV1-17-2700	17,52 mm	2700	3 x 900 mm	2 x 1510-11VA
1511E6EV1-17-2800	17,52 mm	2800	2 x 1400 mm	1 x 1510-11VA
1511E6EV1-17-2900	17,52 mm	2900	900 + 2000 mm	1 x 1510-11VA
1511E6EV1-17-3000	17,52 mm	3000	1400 + 1600 mm	1 x 1510-11VA



MADE  
IN  
GERMANY

**AbZ**  
Z-70.3-244

**System-  
statik**







## Vordach-Wandprofil 1511-21 | Canopy wall profile 1511-21

Material: Aluminium | material: aluminium

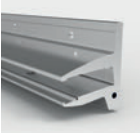
Art.-Nr. Art. no.		Befestigungsbohrung fixation holes	Ausladung outspan	Glasbreite glass width	Gesamtbreite total width
1511E6EV1-21-1400	21,52 mm	7x	≤1100 mm	1398 mm	1407 mm
1511E6EV1-21-1600	21,52 mm	8x	≤1100 mm	1598 mm	1607 mm
1511E6EV1-21-2000	21,52 mm	10x	≤1100 mm	1998 mm	2007 mm
1511E6EV1-21-2400	21,52 mm	12x	≤1100 mm	2398 mm	2407 mm

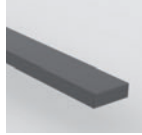
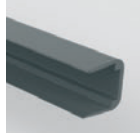
Auch in RAL erhältlich | also available in RAL

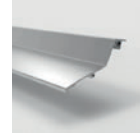
### Set-Inhalt | set contents

								
1x Wandprofil wall profile	1x oberes Verglasungsprofil upper glazing profile	1x Auflageprofil contact profile	1x Kantenschutzprofil edge protection profile	2x Klebeband links/rechts adhesive pad left/right	2x Endkappe inkl. Schrauben links/rechts end cap screws incl. left/right	1x Abdeckblech cladding	3-4x Druckstempel glass support fastener	2x Fixierelement mit Glassicherung glass securing fastener

### Befestigungszubehör | Fixation accessories

 1970-1VA (Ankerstange) (anchor bolt)	 1510-11VA (Verbindungsstift) (connecting stud)	 1501KL-300 (FIS V 300T) (Hochleistungsmörtel) (high performance mortar)	 Z059 (Stirnlochschlüssel) (adjustable face spanner)
 1980 (Siebhülse) (mesh sleeve)	 1024520CTP (10 l) (Montage- und Gleitmittel) (assembly lubricant)	 102476CTP (0,5 l) (Hochleistungs-Montage- und Gleitmittel) (assembly lubricant)	

**Oberfläche | surface**

E6EV1

AbZ = German National Technical Approval



Technische Details | technical details

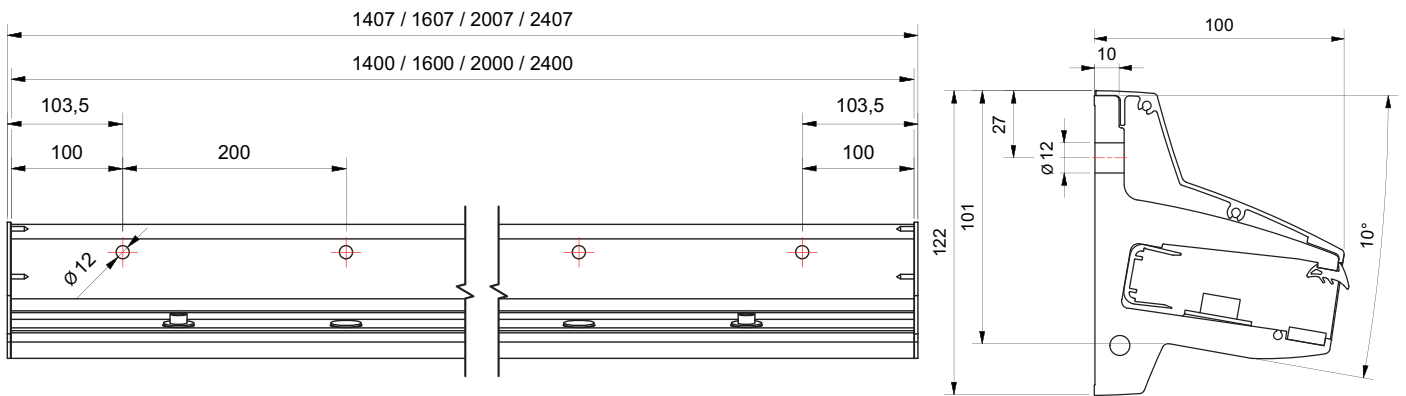

Glasbearbeitung | glass processing



Breite = Profillänge (L) - 2 mm  
width = profile length (L) - 2 mm

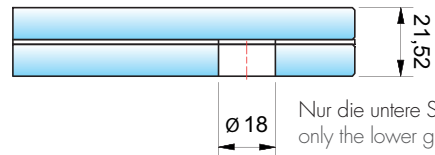
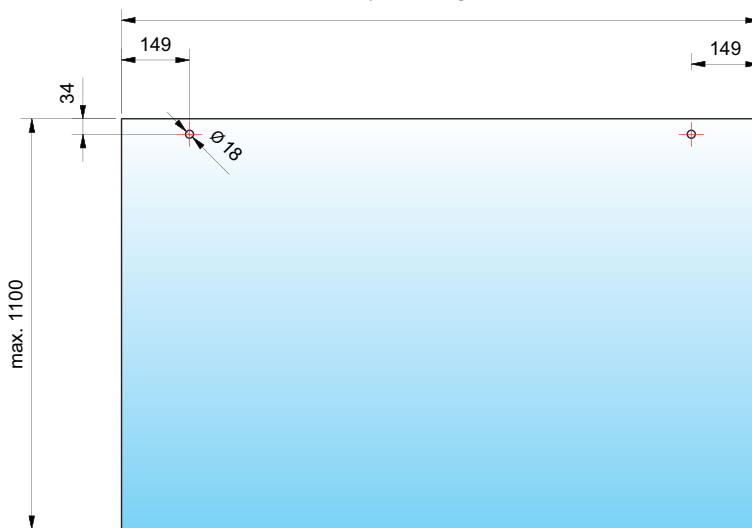

Nur die untere Scheibe wird gebohrt  
only the lower glass panel is drilled

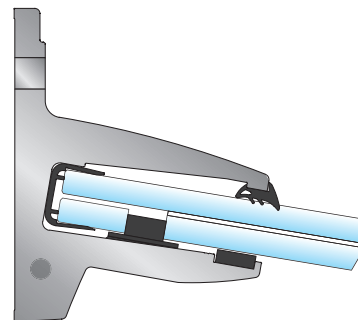

Sollte Ihr Bauvorhaben eine Kombination aus mehreren Vordächern erfordern, bieten wir Ihnen folgende Kombinationsbeispiele an:  
If your building project requires a combination of several canopies, we offer the following combination examples:

Vordach-Wandprofil Kombinationsets 1511-21 | canopy wall profile combination sets 1511-21

Art.-Nr. art. no.		Breite in mm width in mm	Bestehend aus comprised of	Inklusive Verbindungsstift connecting stud included
1511E6EV1-21-1800	21,52 mm	1800	2 x 900 mm	1 x 1510-11VA
1511E6EV1-21-2300	21,52 mm	2300	900 + 1400 mm	1 x 1510-11VA
1511E6EV1-21-2500	21,52 mm	2500	900 + 1600 mm	1 x 1510-11VA
1511E6EV1-21-2700	21,52 mm	2700	3 x 900 mm	2 x 1510-11VA
1511E6EV1-21-2800	21,52 mm	2800	2 x 1400 mm	1 x 1510-11VA
1511E6EV1-21-2900	21,52 mm	2900	900 + 2000 mm	1 x 1510-11VA
1511E6EV1-21-3000	21,52 mm	3000	1400 + 1600 mm	1 x 1510-11VA



Glasscheiben passend zu Vordachsysteme 1510/1511 direkt ab Lager lieferbar  
 glass panels for canopy systems 1510/1511 on stock

MADE  
 IN  
 GERMANY



Breite B | Width B

Breite = Profillänge – 2 mm

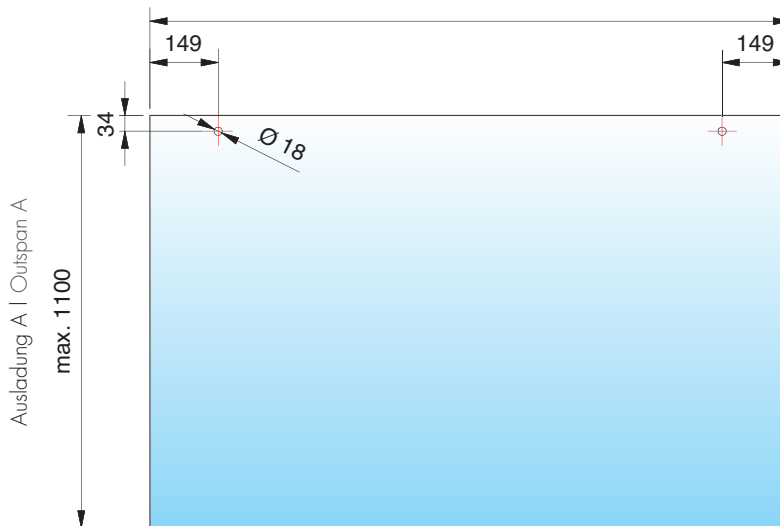

### Glasscheiben für 1510 und 1511 | glass panels for 1510 and 1511

Art.-Nr. Art. no.	Für Profilsystem 1510 / 1511 for profile systems 1510 / 1511	Breite B width B	Ausladung A outspan A
1510GLAS-17-A	1400	1398 mm	900 mm
1510GLAS-17-B	1600	1598 mm	1100 mm
1510GLAS-17-C	2000	1998 mm	1100 mm
1510GLAS-17-D	2400	2398 mm	1100 mm

AbZ = German National Technical Approval



$A_{max} = 900 \text{ mm}$   
 1510E6EV1-17-1400  
 1511E6EV1-17-1400  
 $q_{d, max\downarrow} = 3,98 \text{ kN/m}^2$

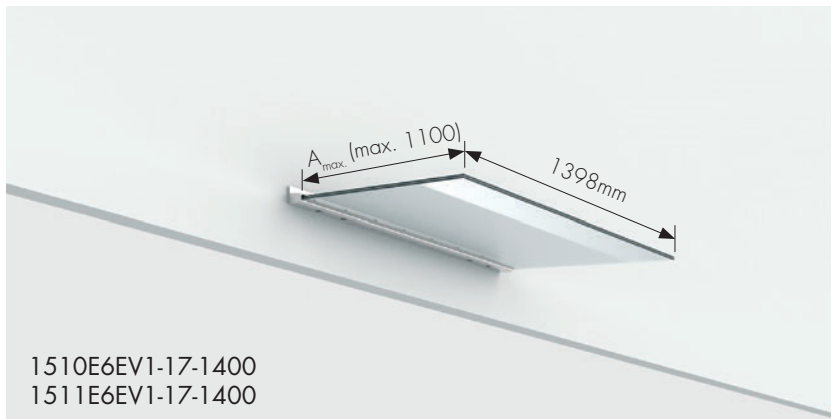

1510E6EV1-17-1400  
 1511E6EV1-17-1400

$A_{max} = 1100 \text{ mm}$   
 1510E6EV1-17-1400  
 1511E6EV1-17-1400  
 $q_{d, max\downarrow} = 2,25 \text{ kN/m}^2$

$A_{max} = 900 \text{ mm}$   
 1510E6EV1-17-1600  
 1511E6EV1-17-1600  
 $q_{d, max\downarrow} = 3,98 \text{ kN/m}^2$

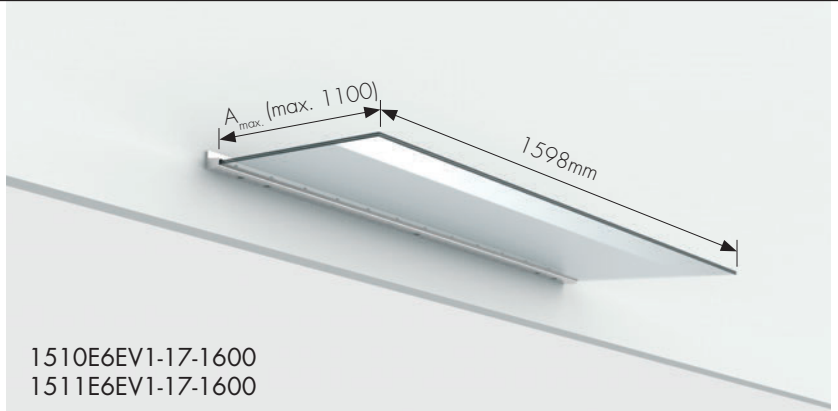

1510E6EV1-17-1600  
 1511E6EV1-17-1600

$A_{max} = 1100 \text{ mm}$   
 1510E6EV1-17-1600  
 1511E6EV1-17-1600  
 $q_{d, max\downarrow} = 2,25 \text{ kN/m}^2$

$A_{max} = 900 \text{ mm}$   
 1510E6EV1-17-2000  
 1511E6EV1-17-2000  
 $q_{d, max\downarrow} = 3,98 \text{ kN/m}^2$

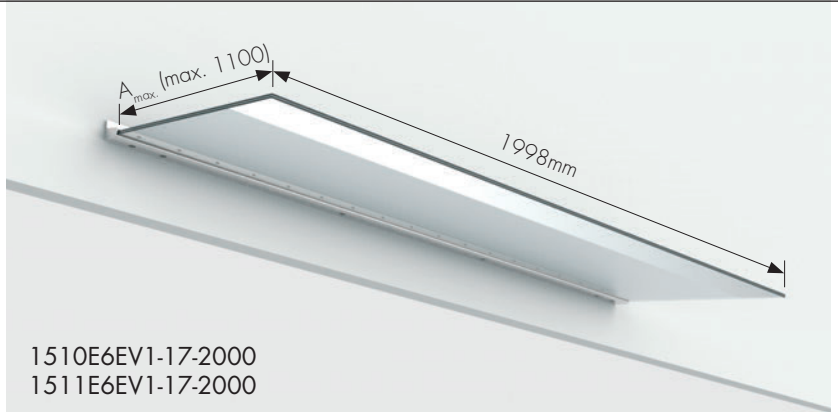

1510E6EV1-17-2000  
 1511E6EV1-17-2000

$A_{max} = 1100 \text{ mm}$   
 1510E6EV1-17-2000  
 1511E6EV1-17-2000  
 $q_{d, max\downarrow} = 2,25 \text{ kN/m}^2$

$A_{max} = 900 \text{ mm}$   
 1510E6EV1-17-2400  
 1511E6EV1-17-2400  
 $q_{d, max\downarrow} = 3,98 \text{ kN/m}^2$

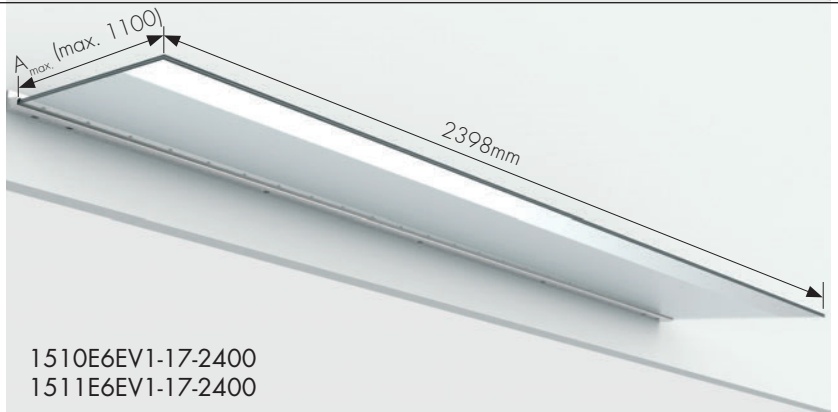

1510E6EV1-17-2400  
 1511E6EV1-17-2400

$A_{max} = 1100 \text{ mm}$   
 1510E6EV1-17-2400  
 1511E6EV1-17-2400  
 $q_{d, max\downarrow} = 2,25 \text{ kN/m}^2$



Nachweis Resttragfähigkeit  
 verified residual load capability



Statik vorhanden  
 static calculation available

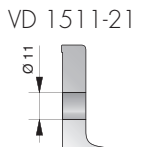
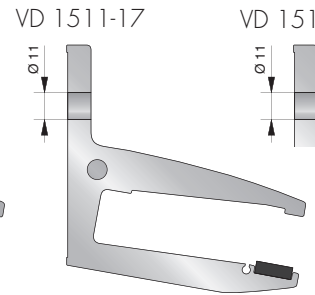
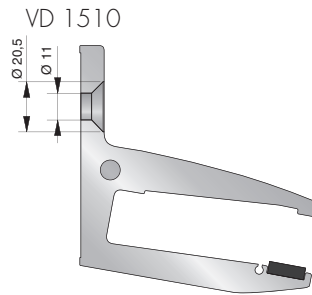
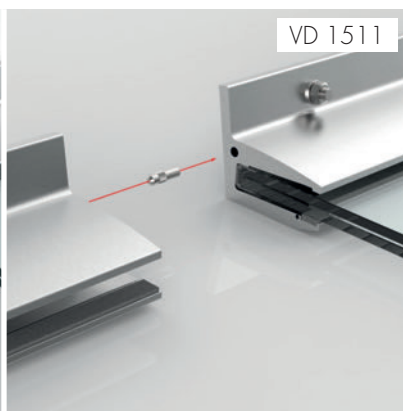
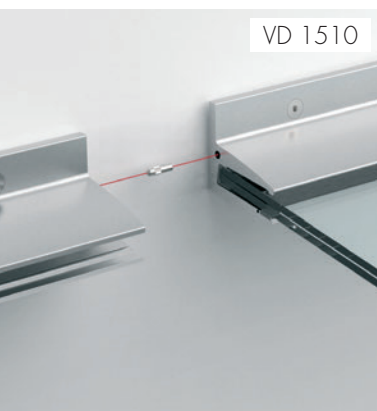
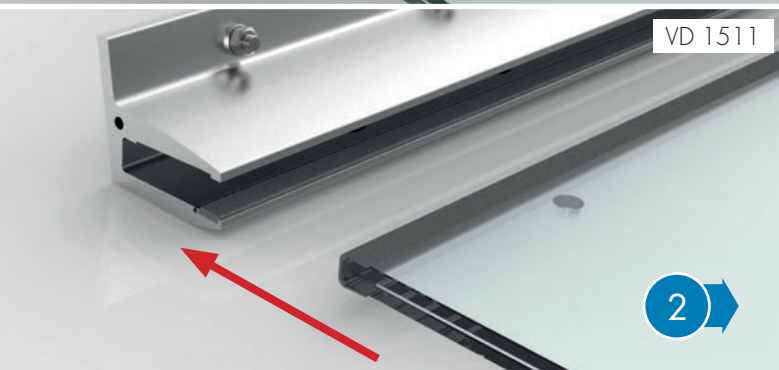
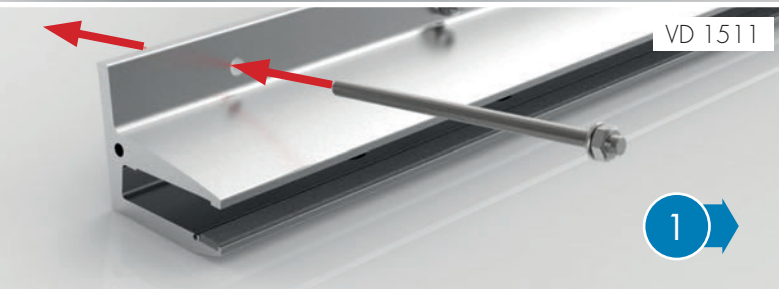
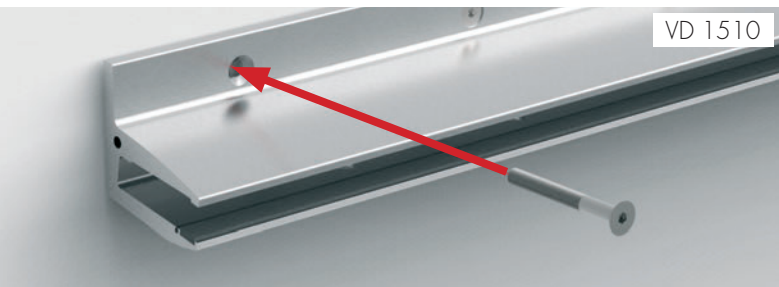

- Profil mit geeignetem Befestigungsmaterial an der Wand montieren.

- mount the aluminum profile with appropriate fastening material to the wall.

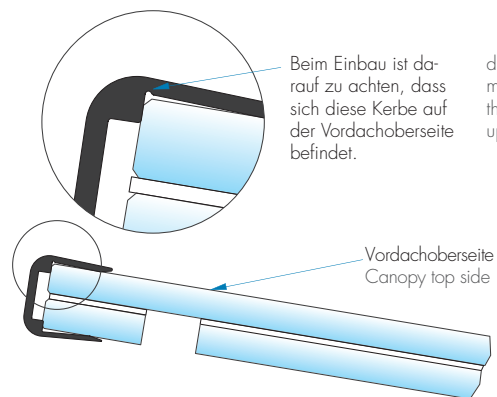

- Kantenschutzprofil auf das Glas stecken (Richtung beachten) und anschließend die Scheibe mit den Bohrlochern nach unten in das Vordachprofil einführen.

- fit the edge protection profile onto the glass (note direction) and then insert the glass panel with the holes facing down into the canopy profile.

Tip: Montage- und Gleitmittel 1024520CTP

Tip: Assembly lubricant 1024520CTP

- Die Profile können mit entsprechenden Verbindungsstiften (1510-11VA) beliebig erweitert werden.

- the profiles can be mounted in series with use of the corresponding connecting studs (1510-11VA).

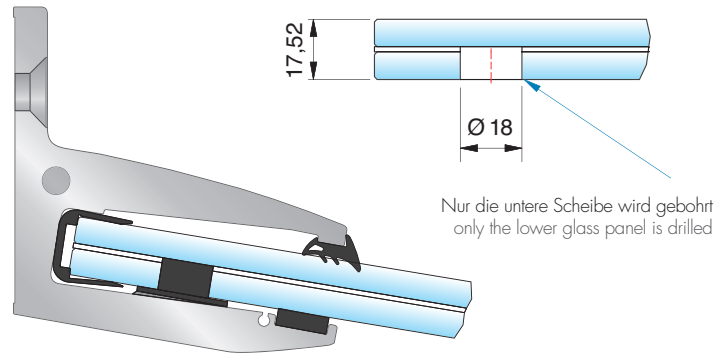

- Glasscheibe ausrichten und mit den Druckstempeln sowie den äußeren Fixierelementen sichern.
- align the glass panel and secure it with the glass supports and fasteners.

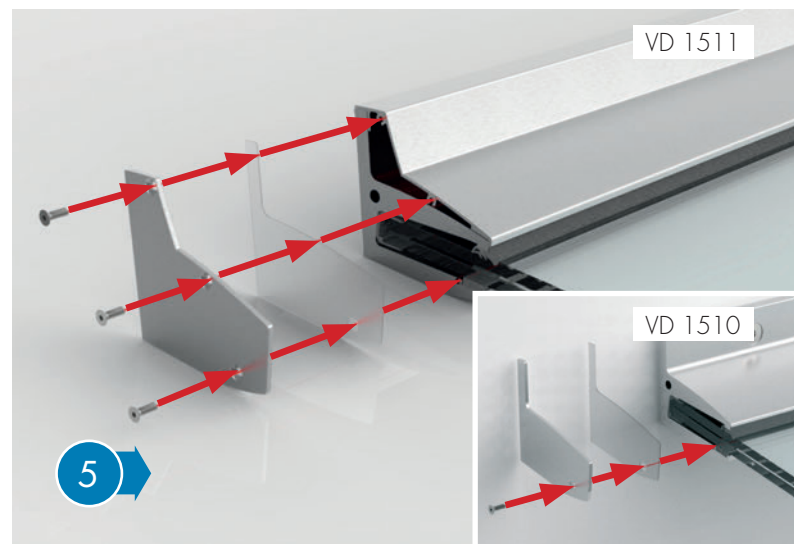

- Obere Verglasungsdichtung einsetzen.
- insert the upper glazing profile.
- Die Abdeckkappen und die Blende (VD 1511) ankleben und verschrauben.
- place the endcaps and the cladding (VD 1511) on the profile and secure them with screws.

Legende | legend



**Allgemeine bauaufsichtliche Zulassung**  
Mit der AbZ wird die Verwendbarkeit bzw. Anwendbarkeit von unregelmäßigen Bauarten nachgewiesen.

**National Technical Approval**  
With the National Technical Approval the usefulness i.e. applicability of regulated design is verified.



**Statik vorhanden**  
Eine Statik für das Produkt ist bei uns vorhanden und kann angefordert werden.

static calculation available

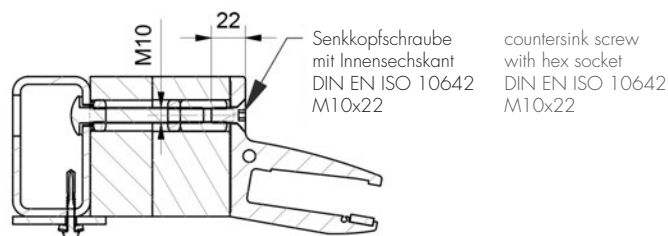
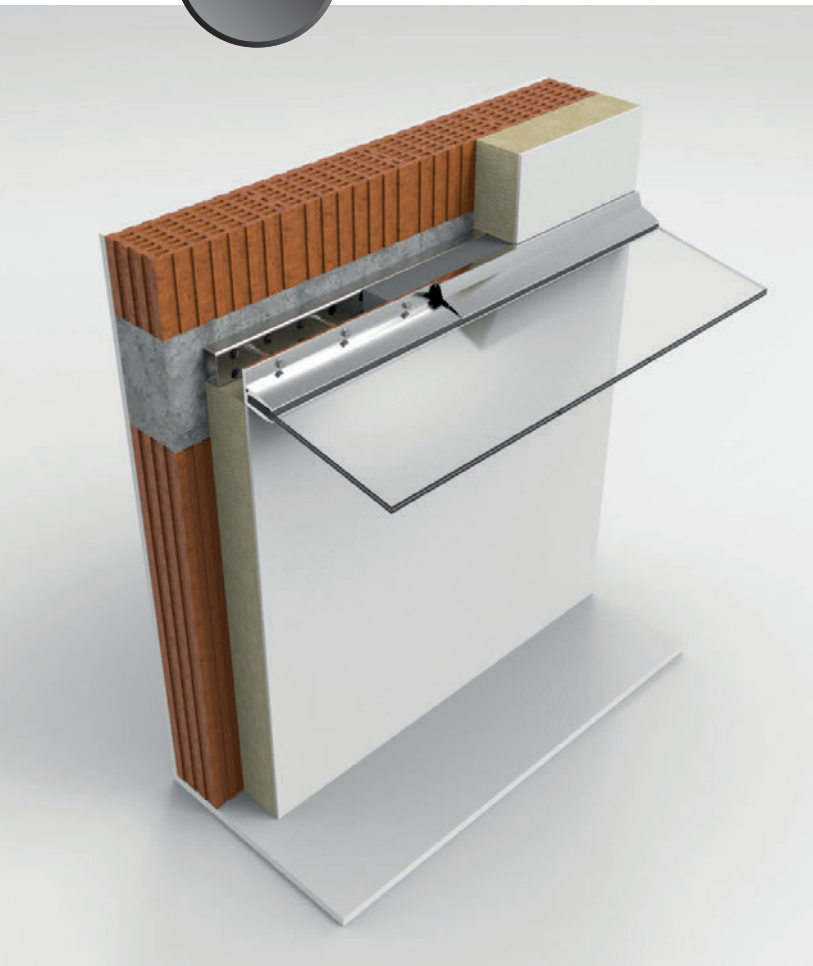

Aufbau 1510E-17 mit Wärmedämmkonsole  
Assembly layout 1510E-17 with thermal insulation console

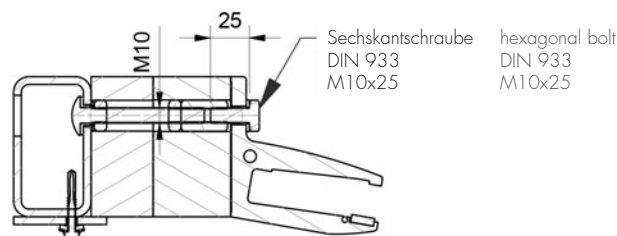

Aufbau 1511E-17 mit Wärmedämmkonsole  
assembly layout 1511E-17 with thermal insulation console

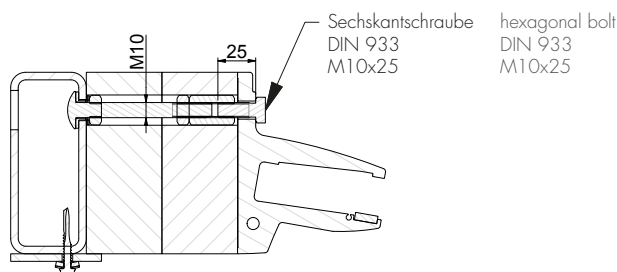

Aufbau 1511E-21 mit Wärmedämmkonsole  
assembly layout 1511E-21 with thermal insulation console

- Für alle Vordachbreiten sind Dämmstoffstärken von 90 bis 200 mm in 10 mm Schritten lieferbar
- Wärmebrücken werden sehr stark reduziert
- Sicheres Anbringen des Vordachs VD1510 / VD1511 auf Wänden mit WDVS

- for all canopy widths, insulation thicknesses are available from 90 to 200 mm in 10 mm increments.
- thermal bridges are greatly reduced
- secure installation of the canopy VD1510 / VD1511 on thermal insulated walls

Wärmedämmkonsole 1519 | thermal insulation console 1519

Art.-Nr. art. no.	Artikelbezeichnung article description	VE/Stück PU/piece
1519	Wärmedämmkonsole thermal insulation console	1/1





## **Pauli + Sohn GmbH**

Werk I:

Eisenstraße 2

D-51545 Waldbröl

Telefon: +49 (0) 22 91-92 06-0

Fax: +49 (0) 22 91-92 06-681

Werk II:

Industriestraße 20

D-51597 Morsbach

Telefon: +49 (0) 22 94-98 03-0

Fax: +49 (0) 22 94-98 03-881

[www.pauli.de](http://www.pauli.de)

[info@pauli.de](mailto:info@pauli.de)